

ecovent[®]mini
heat recovery

Counterflow Heat Recovery Units

Operation & Maintenance Manual



Eagle Close, Chandlers Ford Industrial Estate, Chandlers Ford, Eastleigh, Hampshire, SO53 4NF

Tel: +44 (0) 2380 46 11 50

email: info@ves.co.uk

web: www.ves.co.uk

VES Ref. ID.: VES-DSG-0005
Issue 05
April 2024
Original Instructions

Conventions

Important  This manual must be read in full before Installation, Operation and Maintenance of the units supplied

Please ensure that this document is passed to the end user. This manual forms an integral part of the product and should be kept for the working life of the product. Additional copies of this and supporting documents are available by contacting VES or by visiting www.ves.co.uk and following the 'Download O & M's' link.

The following symbols used within this document refer to potential dangers, advice for safe operation or important points of reference

Warning  Indicates hazards associated with electric current and high voltages

Caution  Indicates hazards that require safety advice for personnel or potential unit/property damage

Important  Indicates important information

Contents		page
1	Introduction	2
2	Nomenclature	3
3	Receipt of Goods & Handling	4
4	Installation	4
5	Standard Wiring & Fan Installation	9
6	Controls Setup	10
7	Maintenance	16

Introduction 1 The ecovent® **mini** series is a range of Heat Recovery units, with duties up to 0.18 m³/s. Suitable for either plantroom, ceiling void or internal locations. As standard, each unit will have been supplied pre-wired to an isolator or fitted control panel, as specified at the time of order. The standard operating temperature of these units is -20 to +40 °C.

For further technical details regarding dimensions and weights, contact VES on **02380 461150**, quoting the sales order (SO) number and the unit type as found on the unit nameplate, or alternatively visit www.ves.co.uk.

Nomenclature 2

Part Number Coding

Point Description	Point Variants	Details (as appropriate)
1 Product	EV	Ecovent® Heat Recovery Units
2 Heat Recovery type	CM	mini Series (<i>Counterflow plate heat exchanger</i>)
3 Unit Size	0...3	Sequential see unit outline for details
4 Fan Type	4...8	Centrifugal EC fan
5 Fan Size	2...7	Sequential
6 Phase	-1	230V 50Hz Single Phase
7 Unit Configuration	/FP	Flat Plantroom
8 Main Heating	Null	No Heating
9 Infill	/DS	Double skinned panel construction
10 Handing <i>(denotes position of supply airflow LIDSAF)</i>	/LT /RT /LB /RB	Left/Top Access Right/Top Access Left/Bottom Access Right/Bottom Access
11 Main Filter	Null /G4 /F7	No filter G4 (Coarse 65%) Pleated filter * F7 (ePM 1 55%) Rigid Pleated Filter *
12 Control Panel Section	/CPSC /ISC	Fitted control panel Fitted isolator/speed controller
13 Colour	Null /R7004	Galvanised finish Powdercoated finish, RAL7004 etc...
14 Finish	MT SG FG LT	Matt Satin Gloss Full Gloss Leatherette
15 Powder Coat Type	Null /IT /BT	As colour Internal powdercoated only Internal/External powdercoated
16 Special	/S	Special (non-standard) Unit

* BS EN ISO 16890 classification

Typical Example

EVCM274-1/FP/DS/LB/G4/CPSC/R9010LT

EV CM 2 7 4 -1 /FP /DS /LB /G4 /CPSC /R9010LT
 ① ② ③ ④ ⑤ ⑥ ⑦ ⑧ ⑨ ⑩ ⑪ ⑫ ⑬ ⑭ ⑮ ⑯

Receipt of Goods & Handling

3 Immediately upon receipt of goods, check for possible damage in transit paying particular attention to fan impellers, drain connections and unit casing. Prior to installation please check to ensure alignment and smooth rotation of the impeller after transit. Also check to ensure that any ancillary items are included. These will normally be supplied fitted or, in the case of small items, taped to the unit.
 In the event of any damage having occurred or if any item is found to be missing, it is essential to inform VES Andover Ltd. within **7 days** of delivery quoting sales order number and the unit type, as found on the unit nameplate. After this period, VES would be unable to accept any claim for damaged or missing goods.

Installation

4 The entire system must be considered for safety purposes and it is the responsibility of the installer to ensure that all of the equipment is installed in compliance with the manufacturer's recommendations, with due regard to the current HEALTH AND SAFETY AT WORK ACT and conforms to all relevant statutory regulations.
 Where a unit is installed so that a failure of components could result in injury to personnel, precautions should be taken to prevent such an injury. If the unit is installed where there is a reasonable possibility of persons or objects coming into contact with the impeller whilst operational, a guard should be fitted or steps taken to prevent this. It is the installer's responsibility to ensure that access panels are not obstructed in any way and safe working access for maintenance must be provided in accordance with Health and Safety and Building Regulations. For confirmation of required access please see the appropriate unit outline drawing.
 Consideration must also be given by the installer for adequate illumination of the unit location in order for safe maintenance. Further consideration should be given to the unit's position and secured into place as appropriate.

Caution  Mounting hangers, door furniture, isolators etc. extend beyond the casework and so are vulnerable to accidental damage. Take necessary precautions so as not to cause damage whilst handling the unit.

The weight of each unit/section is specified on the outline drawing and the total unit weight will be displayed on the unit inspection label. When lifting the unit using a fork lift truck ensure the whole unit is supported by the full length of the forks. It may be necessary to use fork extensions to fully support the unit properly. The centre of gravity may be offset from the centre of the unit; this needs to be taken into consideration when lifting the unit.

Fork Lifting Detail
 Fig. 1

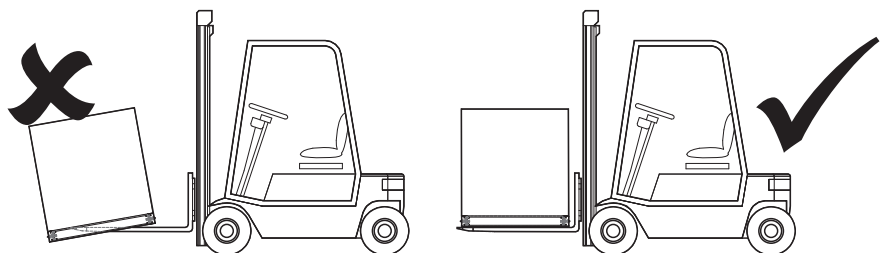

Caution  Handle with care. Failure to fully support the unit during lifting may result in damage to the unit.

Lifting Detail
 Fig. 2

Units are to be rigged and lifted using spreaders, taking into account the weight of the unit, and lifting gear should be arranged so as not to bear on the casework see right.

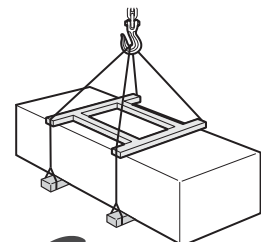

Installation 4 Continued

ecovent® mini units are supplied with feet suitable for ceiling-void mounting, by use of drop-rod mounting, in bottom access orientation, with airflow in the horizontal plane. For alternative mounting please consult your outline drawing as supplied with the unit, or refer to VES Customer Services for further information. Secure drop rods/unit with the appropriate fixings as shown below **3**.

Unit mounting detail
Fig. 3

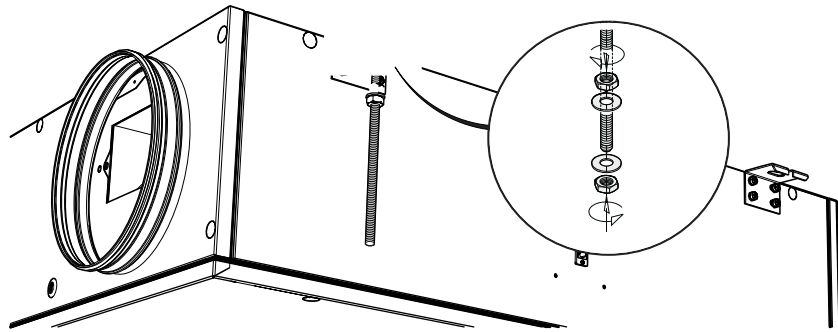

Important



When hanging units from drop-rods, ensure that the load is evenly spread and that **ALL** feet are used within the support, including those for fitted silencers if included. Ensure that the drop rod used is selected appropriately to accommodate the load of the unit. Please consult the unit outline drawing for specific unit weight when choosing suitable fixings.

Alternate Mounting
Fig. 4

For installations using a metal framing systems (such as unistrut etc.) the feet can be rotated 180° to allow for better ceiling clearance. Carefully remove/retain the fixings and reposition the feet as required. Ensure all fixings are correctly reinstated and tighten to 8Nm.

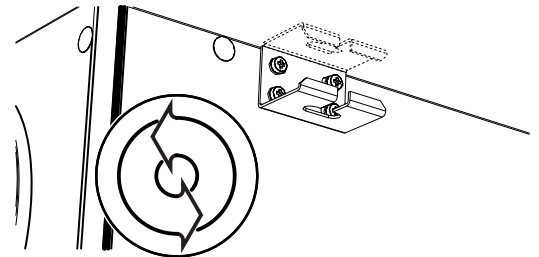

Section joining detail
Fig. 5

When units and ancillary modules are supplied separately, it is important that all sections are joined together securely prior to positioning and installation. This should be assembled using self adhesive rubber tape at the joints prior to assembly to prevent possible air leakage; replace with similar if damaged. Finish the assembly by installing the joint fixings to both parts, brackets are secured to the casework using M6 Pozzi screws. Tighten together using a 6mm hex key, drawing both sections together evenly.

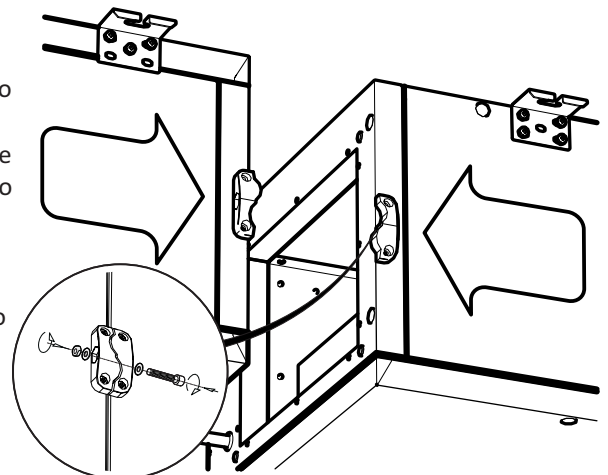

Caution



Joining brackets are **NOT** structural and are included as part of the unit sealing only. When moving assembled units ensure that **ALL** sections are fully supported.

Installation 4 Continued
Access

Caution 

When accessing the unit ensure the access panels are handled/opened in a controlled manner so as to avoid damage to the unit or injury to personnel. This is particularly important with bottom access units. Ensure the AHU has been given time to come to a complete stop before attempting any work to the unit

The main bottom Access panels are held into position using 8No. M6 Panhead Pozi Fixings. Updated for 2024, ecovent® mini unit sizes 1 and 2 feature an additional small controls access hatch to assist with on-site wiring.

To remove, ensure the access panels are fully supported. Carefully remove/retain the black cover caps and remove the screw fixings retained within. Ensure all fixings are correctly reinstated and tighten to 8Nm upon re-assembly.

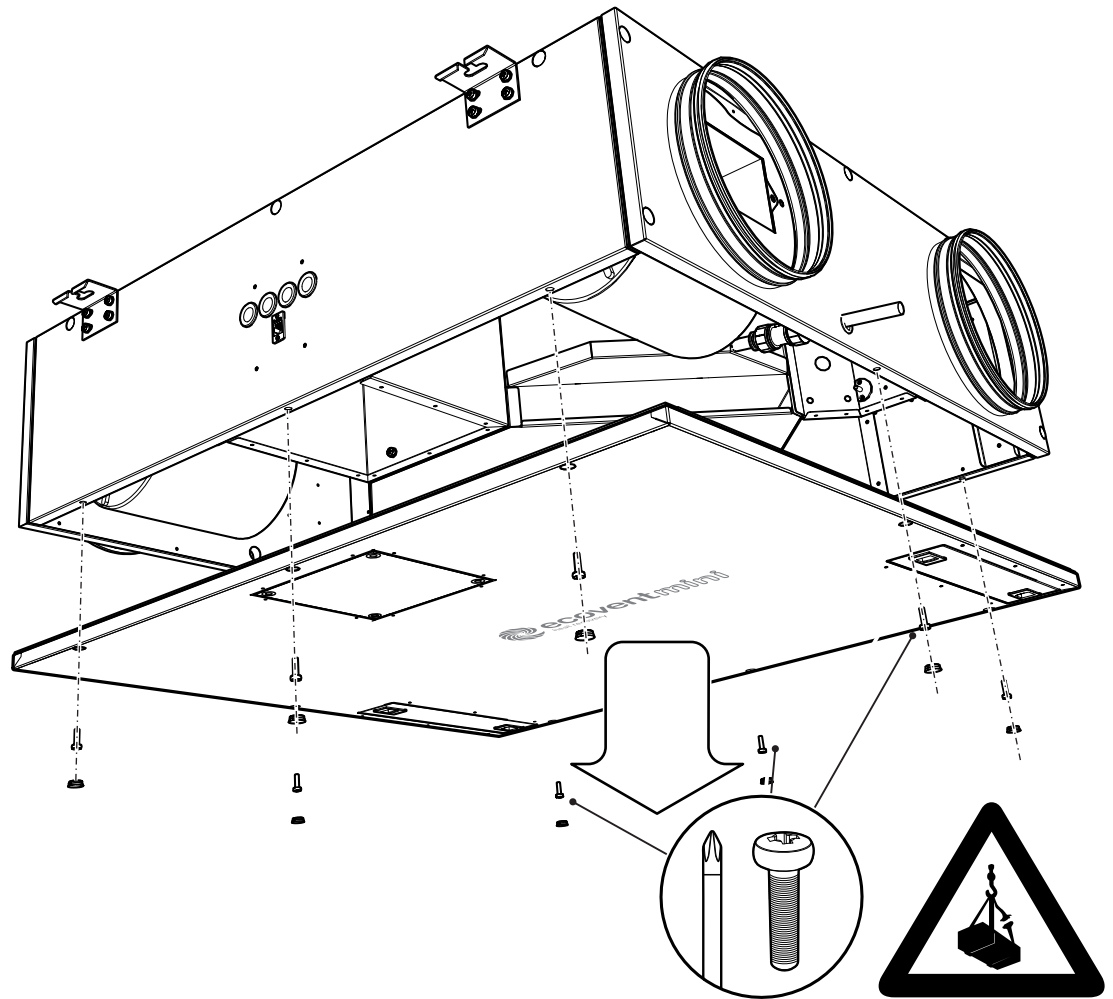

Unit Access
Fig. 6

Important 

For correct filter access and servicing, please see section 7 Maintenance for full details

Electric Heater Batteries

For units with ancillary heating please see the appropriate product O&M VES ID Ref. VES-DSG-0010.

Installation
Condensation

4 Continued

The unit is fitted with a drain pan terminated to a Ø15mm internal drain spigot and a Hep20 push fit straight connector. Join through the case using the hole provided into the connector, trap as required and terminate via an appropriate waste system or by use of a peristaltic pump.

Typical Ecovent
Drainpan Installation
Fig. 7

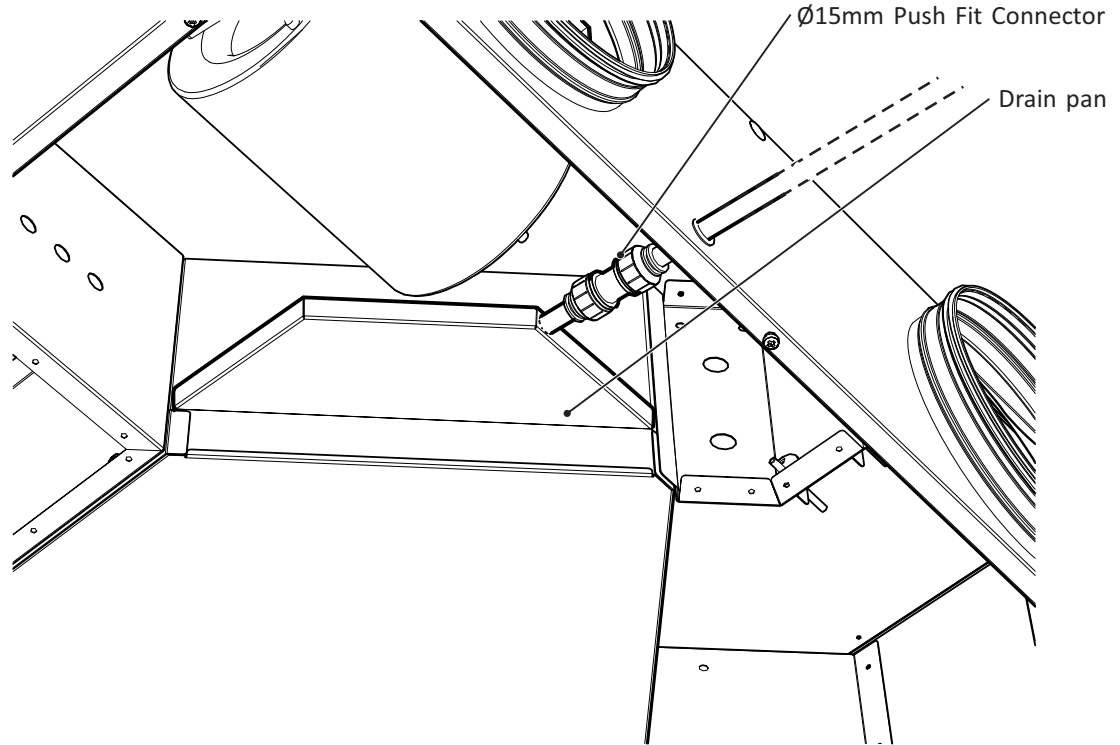

Typical trapping detail
Fig. 8

Drain pan fitted to a heat exchanger, diagrams show situation with fan operational.

Drain to open tundish as shown above.

DIM H = TOTAL STATIC PRESSURE mm Wg + S

S = SAFETY ALLOWANCE 25mm

Example: If H=250Pa (25mm) + safety allowance (25mm) = 50mm

Negative pressure

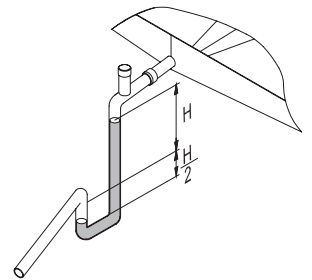

Caution



It is important that the drain be allowed to clear without obstruction. Ensure that the unit is mounted level and the drainpan is angled so that water drains towards the drain spigot as the drain may have moved during transit/installation. Failure to do this may result in excess condensation within the unit and possible flooding.

Installation
Condensation
Damper Sections

4 Continued

Where units are required to be fitted with a sectional damper module, it may be necessary to re-route the condensate outlet pipe. A connecting push-fit style elbow and short length of pipe will have been provided within the damper module.

- Remove the damper section bottom access cover, **keeping all fixings**.
- Connect the elbow to the short condensate drainpipe exiting the main unit.
- Make sure the connection is fully made in line with the proprietary manufacturer's recommendations.
- Slide the longer length of pipe through the hole in the casework, into the damper section and make the connection with the elbow.
- Ensure the pipework and connections are watertight.
- Trap or route the condensate to a suitable waste water outlet.
- Replace the bottom access cover, reinstating all fixings

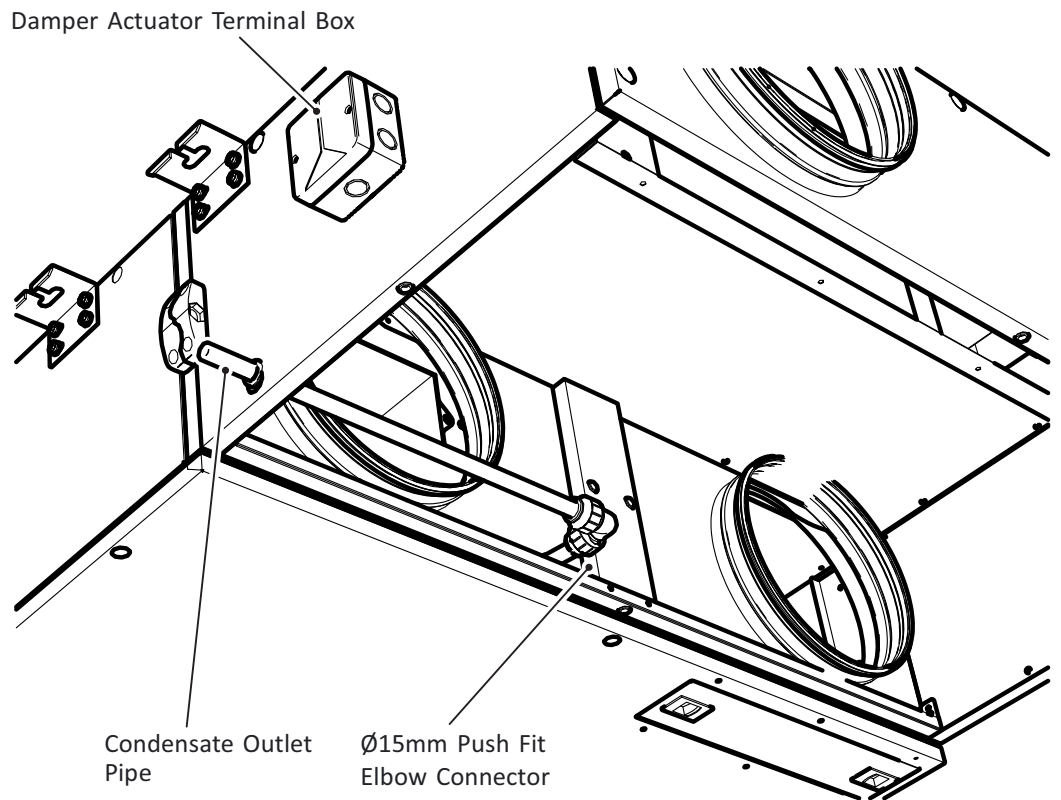

Damper Section
 Condensate detail
 Fig. 9

Standard Wiring & Fan Installation 5

Warning ⚡ The electrical supply **MUST BE FULLY ISOLATED** before attempting to affect any work on this unit. All electrical connections to any unit must be carried out in accordance with the current edition of the I.E.T. Regulations, only competent Electricians should be allowed to affect any electrical work to our units.

Important ! It is recommended that the cable entry point should be at the side of the unit as shown below in figure 10. It is the responsibility of the installer to ensure that a suitable cable gland (giving adequate protection and strain relief) is fitted, and in doing so also ensure that no internal components are damaged during this installation. Take particular care to note the position of the drain and associated pipework. Make certain any swarf produced is removed before use. It is the installer's responsibility to supply earth protection through the building installation device and a dedicated, isolated power 220-240VAC 50Hz supply with overload protection, to account for motor start up currents. See below for specific 11 details Fig. The installer must provide a switched fused spur. The spur must be a 5 Amp, double pole connection point that is local to the unit (the contact separation of the fused spur switch should be at least 3mm).

Warning ⚡ Do not connect any unit to an electrical supply voltage outside of the specification.

Recommended cable entry points Fig. 10

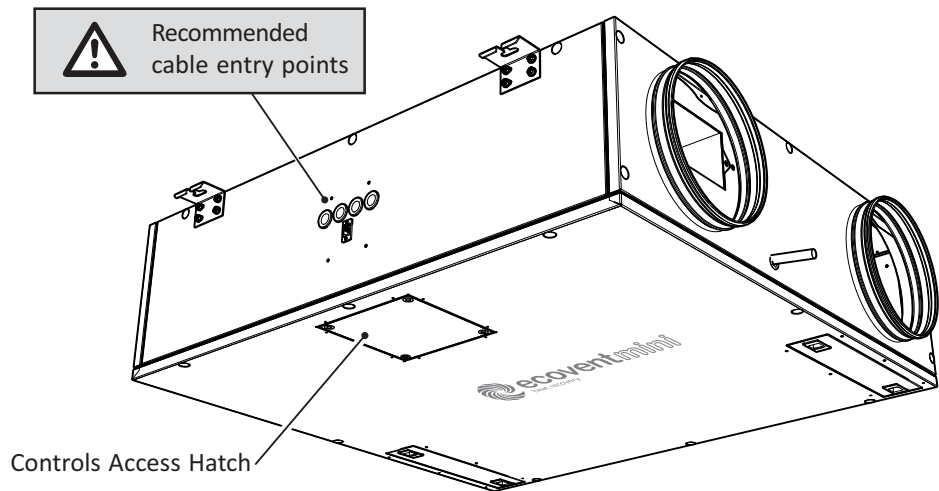

Important ! For all units with fitted controls and for ancillary items, please see the accompanying wiring diagram for full details or contact VES Customer Services Department on 02380 461150, quoting the sales order (SO) number and, quoting the sales order (SO) number and unit type as found on the unit name plate.

Standard Fan Details Fig. 11

	Size	Phase	Motor Size	Voltage	Fan Speed rpm	Full Load Current	Speed Control
EVC	174-1	1	0.100 kW	230 VAC	1410	0.83 A	EC
	274-1	1	0.100 kW	230 VAC	1410	0.83 A	EC
	353-1	1	0.170 kW	230 VAC	2860	1.75 A	EC

Controls Setup 6

Caution  The following set up should only be undertaken by a competent commissioning engineer. Incorrect adjustment will adversely affect the accuracy and performance of the system

Controls Interface

Although the controls will interface with a building management system (BMS), initial setup can only be completed using a handheld human-machine interface (HMI) which will have been supplied with the order. There are two versions of HMI available, a roller button version and a six-button version. The button operation is described below but the menu operation is the same for both.

There are two modes of operations available. Read only mode, whereby several parameters may be viewed for a quick visual inspection of the systems current state and Commissioning mode, which allows the user to view and edit all parameters. This includes functions such as adjusting fan speeds, temperature setpoints, heating type and integrated communications settings. Commissioning mode is typically indicated by the presence of **3 keys** in the top right-hand corner, in read only mode this will be blank.

HMI Variants
Fig 12

PSEL900461
(Six button HMI)

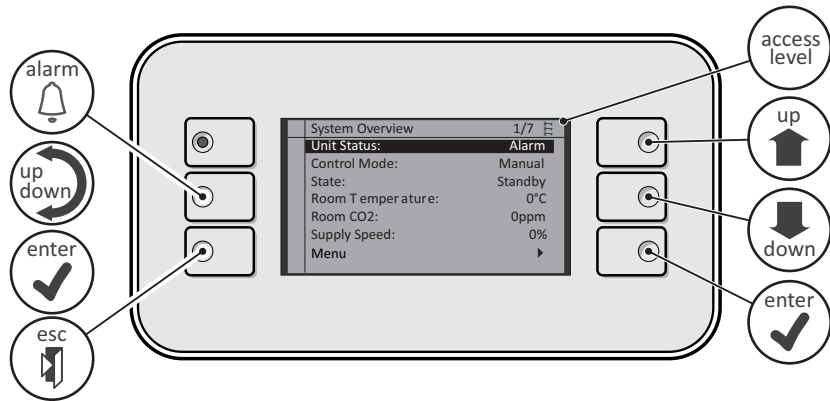

PSEL900463
(Roller button HMI)

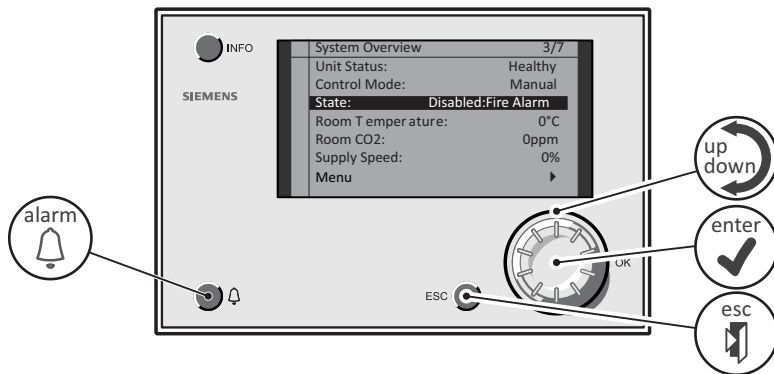

Controls Setup 6 Continued

Starting the unit

① Plug the HMI into the RJ45 Socket on to unit as shown. Note: when the HMI is first plugged in, it may take up to 45 seconds before the HMI is ready

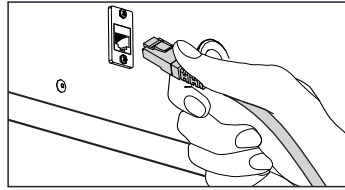

② Using the **up** and **down** buttons on the HMI, move to the **System Switch** field and press **enter**.

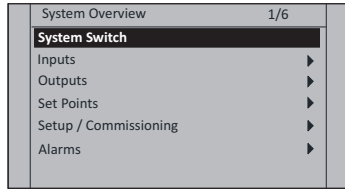

③ Using the **up** and **down** buttons on the HMI, move to the **ON** field and press **enter**.

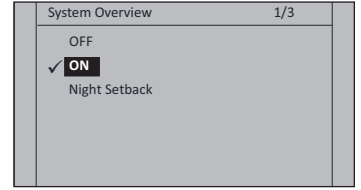

④ The unit should now run, in conjunction with the supply fan and extract fan setpoint parameters.

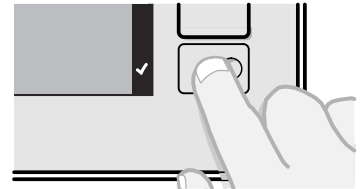

Setting fan speeds

① Plug the HMI into the RJ45 Socket on to unit as shown.

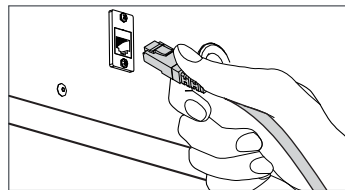

② Using the **up** and **down** buttons on the HMI, move to the **Set Points** field and press **enter**.

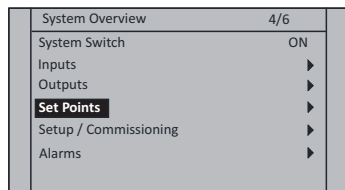

⑦ Using the **up** and **down** buttons on the HMI, move to the **Manual Override** field and press **enter**.

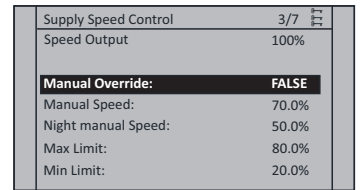

⑧ Using the **up** and **down** buttons on the HMI, move to the **TRUE** field and press **enter**. Press the **escape** button to return to the previous screen.

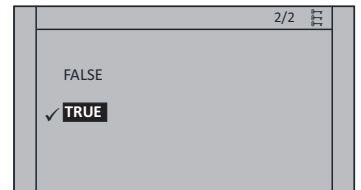

③ Move to **To Edit Enter Password** and press **enter**.

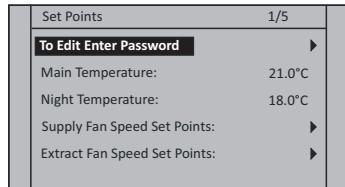

⑨ Using the **up** and **down** buttons on the HMI, move to the **Manual Speed** field and press **enter**.

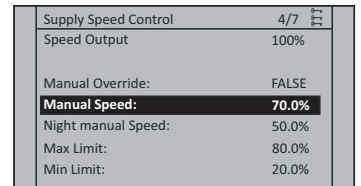

④ Enter password **5973**. This will now return you to the system overview screen. Note: There should be 3 keys in the top right-hand corner to indicate commissioning mode.

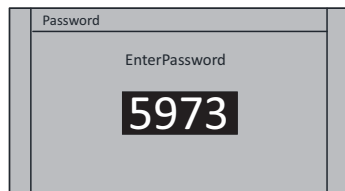

⑩ Using the **up** and **down** buttons on the HMI, adjust the fan speed and measure the unit airflow to achieve the desired duty rate. Press **enter** once complete. Repeat the process for Night Manual Speed; Max Limit and Min Limit as required.

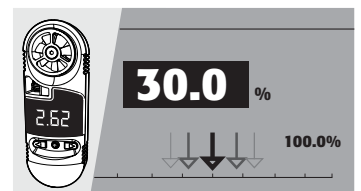

⑤ Using the **up** and **down** buttons on the HMI, move to the **Set Points** field and press **enter**.

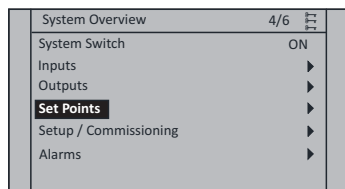

⑪ Once complete, **long press** the **enter** button and press **enter** to log off.

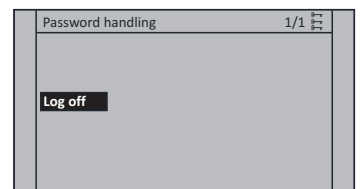

⑥ Using the **up** and **down** buttons on the HMI, move to the **Supply Fan Speed Set Points** and/or **Extract Fan Speed Set Points** field and press **enter**.

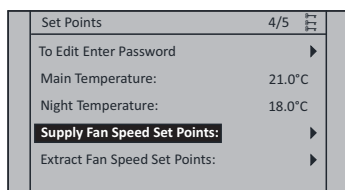

Controls Setup 6 Continued Selecting Heating Type

① Plug the HMI into the RJ45 Socket on to unit as shown.

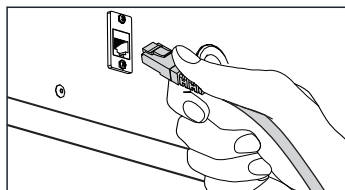

② Using the **up** and **down** buttons on the HMI, move to the **Setup / Commissioning** field and press **enter**.

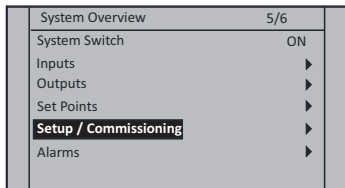

③ Move to **To Edit Enter Password** and press **enter**.

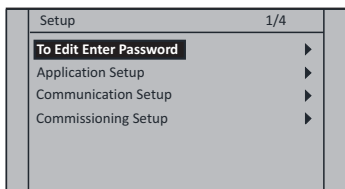

④ Enter password **5973**.
Note: There should be 3 keys in the top right-hand corner to indicate commissioning mode.

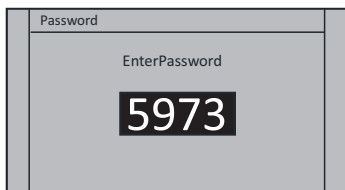

⑤ Using the **up** and **down** buttons on the HMI, move to the **Setup/Commissioning** field and press **enter**.

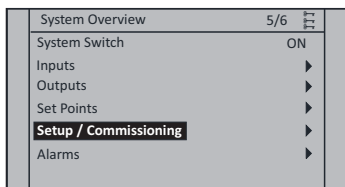

⑥ Using the **up** and **down** buttons on the HMI, move to the **Application Setup** field and press **enter**.

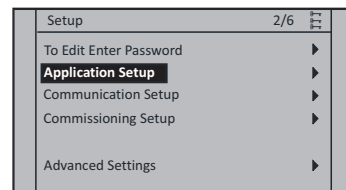

⑦ Using the **up** and **down** buttons on the HMI, move to the **Heating** field and press **enter**.

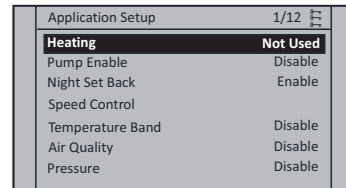

⑧ Using the **up** and **down** buttons on the HMI, move to the desired heating type as required and press **enter**.
Note: the system will utilise the heat recovery device in the first instance. If ancillary heating has been installed, this will top up the heat according to demand.

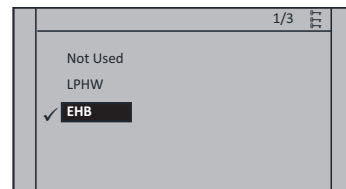

⑨ Once complete, **long press** the **enter** button and press **enter** to **log off**.

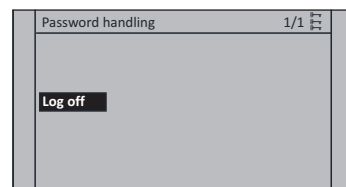

Controls Setup 6 Continued

Setting Temperature Set Points

① Plug the HMI into the RJ45 Socket on to unit as shown.

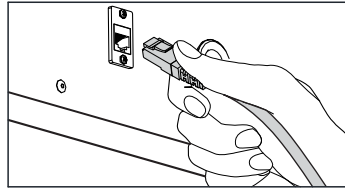

② Using the **up** and **down** buttons on the HMI, move to the **Set Points** field and press **enter**.

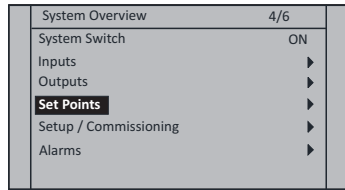

③ Move to **To Edit Enter Password** and press **enter**.

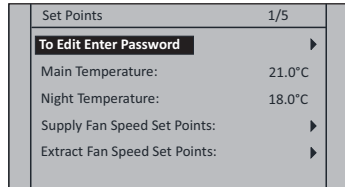

④ Enter password **5973**. This will now return you to the system overview screen.

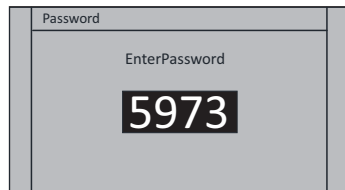

⑤ Using the **up** and **down** buttons on the HMI, move to the **Set Points** field and press **enter**.

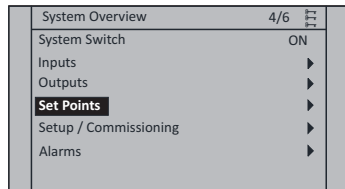

⑥ Using the **up** and **down** buttons on the HMI, move to the **Main Temperature** field and press **enter**.

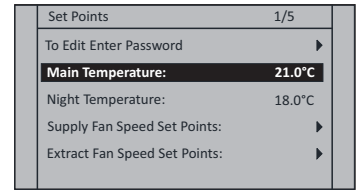

⑦ Using the **up** and **down** buttons on the HMI, adjust the temperature to achieve the desired set point. Press **enter** once complete.

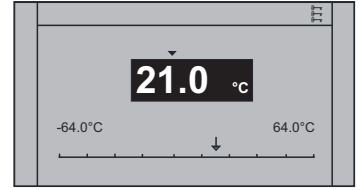

Note: the system will utilise the heat recovery device in the first instance. If ancillary heating has been installed, this will top up the heat according to demand.

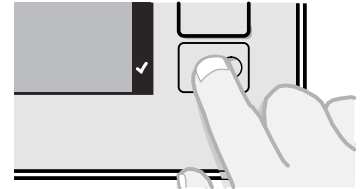

Repeat the process for Night Temperature as required.

⑧ Once complete, **long press** the **enter** button and press **enter** to **log off**.

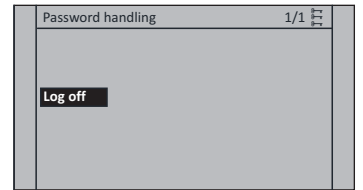

Controls Setup Communications Settings

6

Continued

① Plug the HMI into the RJ45 Socket on to unit as shown.

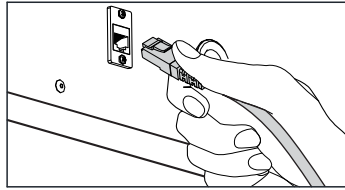

② Using the **up** and **down** buttons on the HMI, move to the **Setup/Commissioning** field and press **enter**.

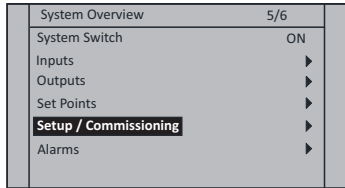

③ Move to **To Edit Enter Password** and press **enter**.

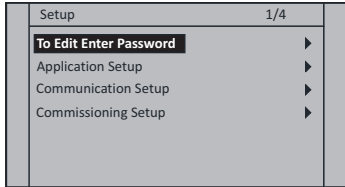

④ Enter password **5973**. This will now return you to the system overview screen.

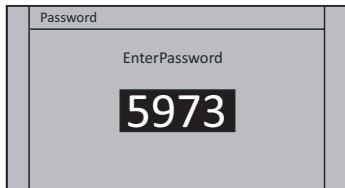

⑤ Using the **up** and **down** buttons on the HMI, move to the **Setup/Commissioning** field and press **enter**.

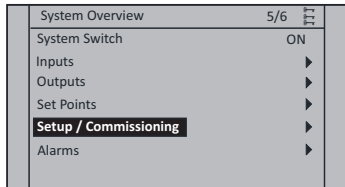

⑥ Using the **up** and **down** buttons on the HMI, move to the **Communication Setup** field and press **enter**.

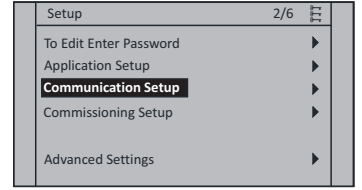

⑦ Using the **up** and **down** buttons on the HMI, select either **Modbus** or **BACnet** and press **enter**. Adjust settings as appropriate.

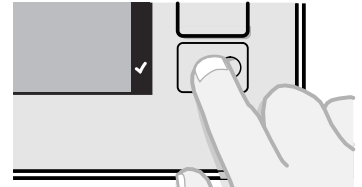
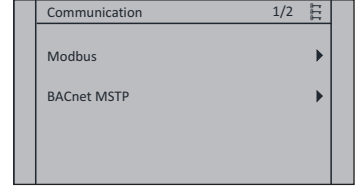

⑧ Once complete, **long press** the **enter** button and press **enter** to **log off**.

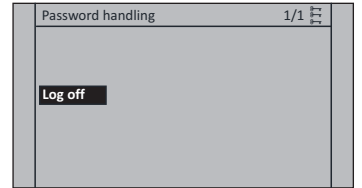

Controls Setup Troubleshooting 6 Continued

① Plug the HMI into the RJ45 Socket on to unit as shown. If the alarm button is illuminated and/or flashing, this indicates a fault within the system. Press **alarm** button to view the details of the fault and act accordingly.

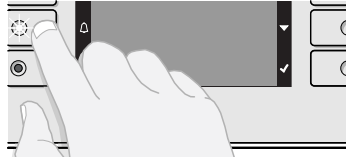
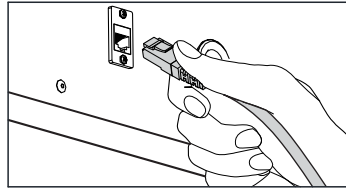

② To acknowledge the alarm, using the **up** and **down** buttons on the HMI, move to the **Alarms** field and press the **enter** button.

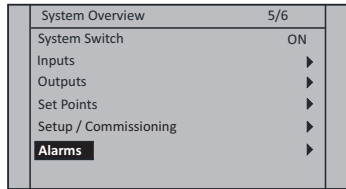

③ Move to **To Acknowledge Enter Password** and press **enter**.

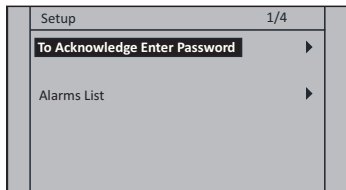

④ Enter password **5973**. This will now return you to the system overview screen.

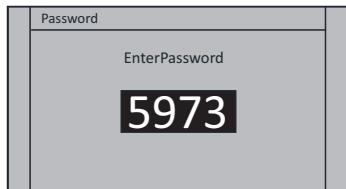

⑤ Using the **up** and **down** buttons on the HMI, move to the **Alarms** field and press the **enter** button.

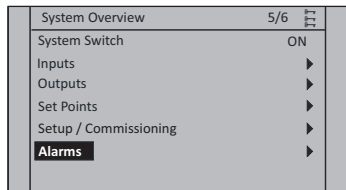

⑥ Using the **up** and **down** buttons on the HMI, move to the **Alarms List** field and press the **enter** button.

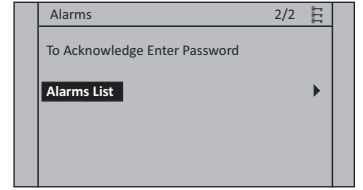

⑦ Using the **up** and **down** buttons on the HMI, move to the **Acknowledge** field and press **enter**.

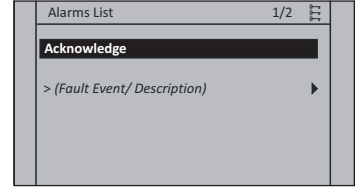

⑧ Using the **up** and **down** buttons on the HMI, move to the **Execute** field and press **enter**.

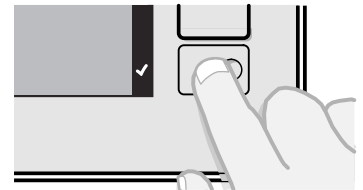
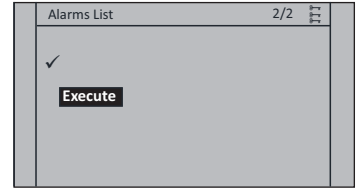

⑨ Once complete, long press the **enter** button and press enter to **log off**.

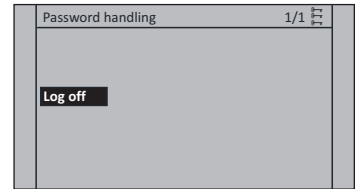

Maintenance 7

Important 

Before attempting to carry out any work on our units, all accompanying documentation including warning labels on the unit must be referenced. Should it be necessary to remove any component ensure that these are secured into position once reinstalled. It is critical that after any maintenance work has been conducted that all components removed/replaced be refitted correctly by a competent engineer.

Warning 

Before attempting to carry out any maintenance work, investigative or repair work on our units, the unit **MUST BE COMPLETELY ISOLATED** from its electrical supply. Ensure a minimum of two minutes after electrical disconnection before removing access panels. This will allow any moving parts to come to a rest. Care should also be taken when accessing external units as the wind and elements may cause moving parts to ‘windmill’.

In general, this series of units require little maintenance. In the unlikely event of component failure, spares are available from stock at VES Andover Ltd. See Fig. 21

Caution 

When accessing the unit ensure the access panels are handled/opened in a controlled manner so as to avoid damage to the unit or injury to personnel. This is particularly important with bottom access units. Ensure the AHU has been allowed to completely cool before attempting any work to the unit

For bottom access units, should it be necessary to remove the heat exchanger and/or drainpan assembly from the unit casework take care to ensure that all components are correctly supported during their removal. Remove lids from the unit, exposing the key components. Damper and bypass assemblies are held into position using M6 fixings. Remove the required components with care and ensure that all components are replace correctly.

ecovent® mini units feature plug & socket connections to allow easy removal/replacement of key components. Separate the plug connection by hand by pressing the top/bottom clasp mechanism to open

Plug & socket operation
Fig. 13

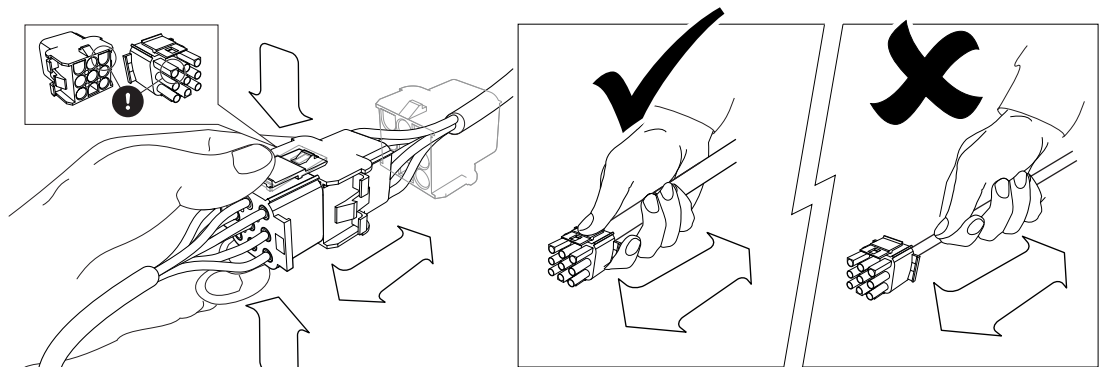

On reconnection, the assembly features a locating lug to ensure correct orientation. Once rejoined, lock the connection together again using the system as shown. Note the plugs are handed and forcing an incorrect connection may result in damage to the plug.

Caution 

Gently pull apart the plugs to separate, **DO NOT pull the cables to separate the assembly**

Maintenance 7 Continued
Key Components
EVCM1 & 2

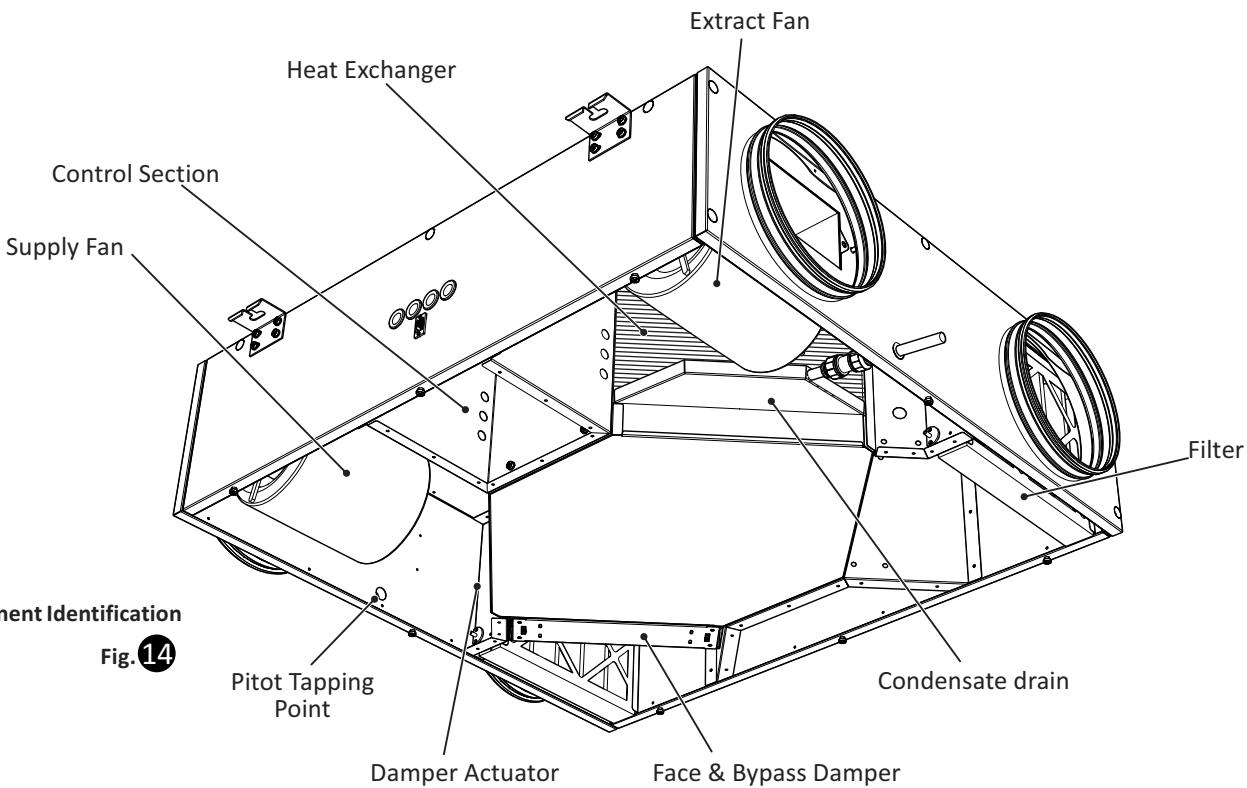
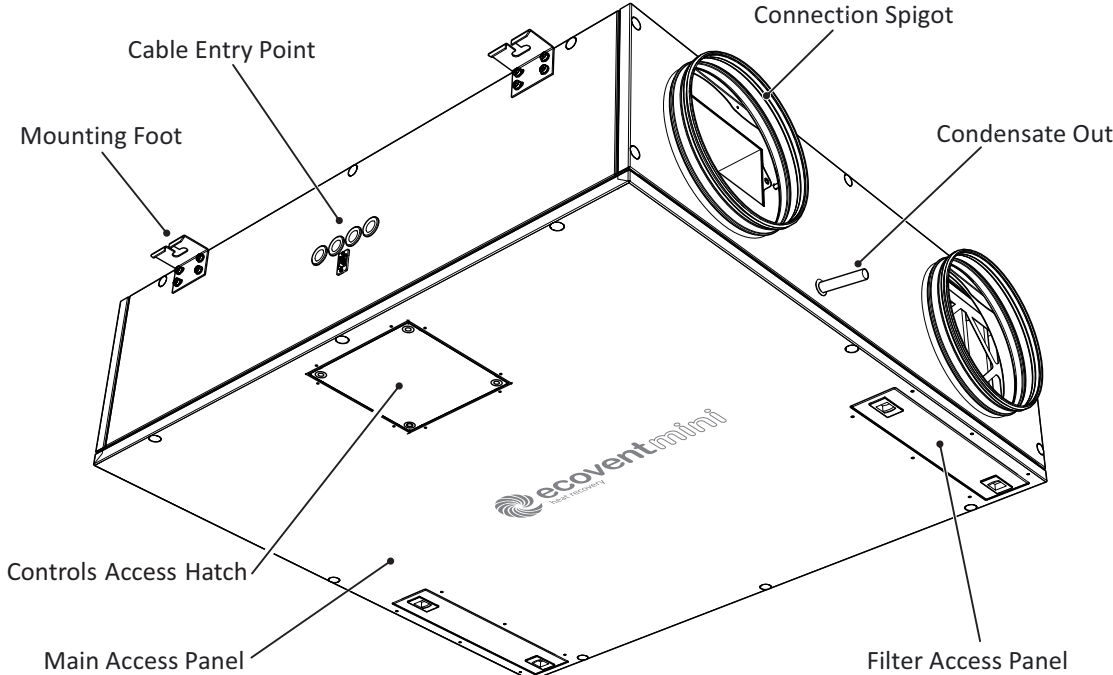

Component Identification
Fig. 14

Note: Unit shown LHS Bottom Access

Maintenance 7 Continued

Key Components
EVCM3

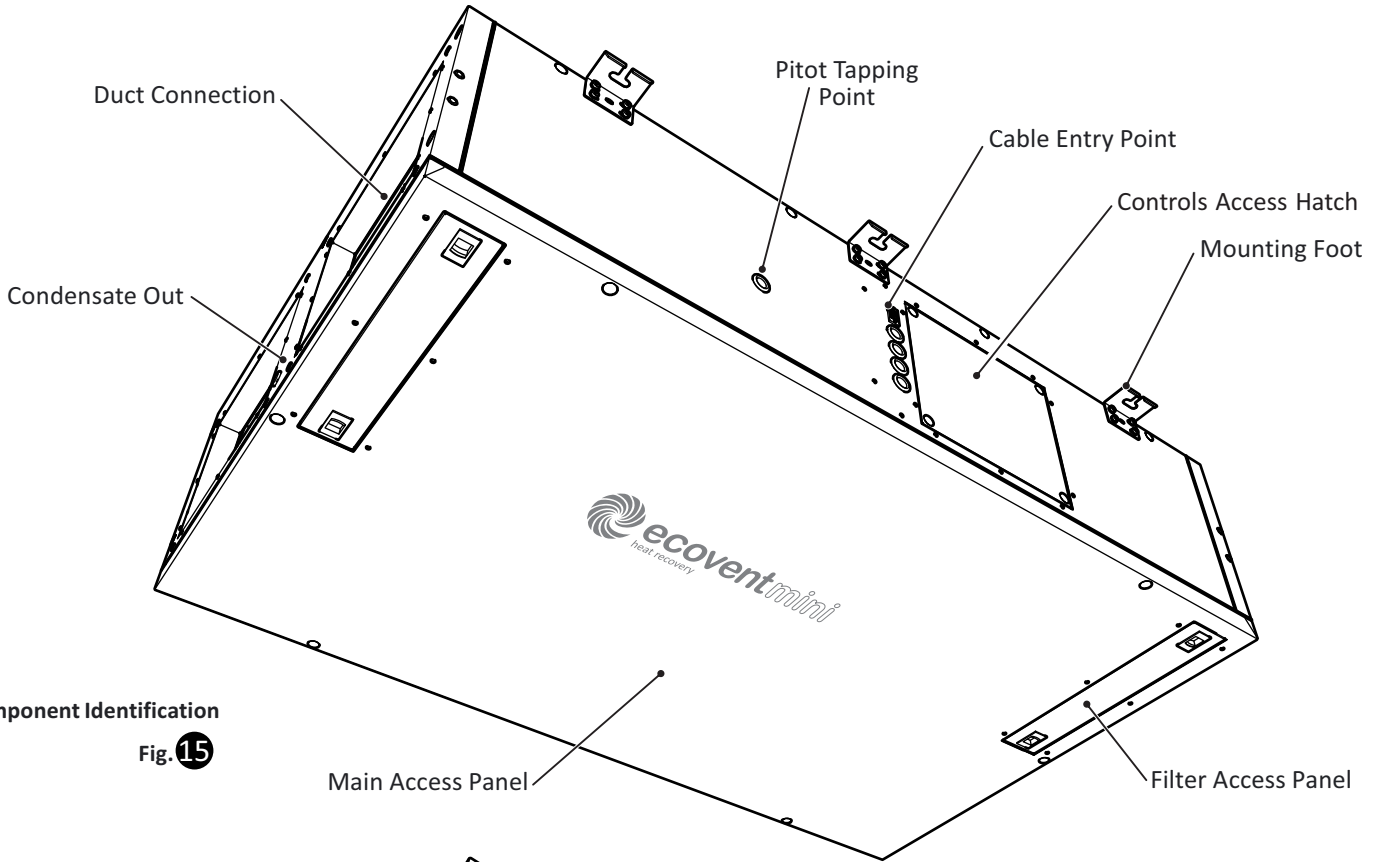

Component Identification

Fig. 15

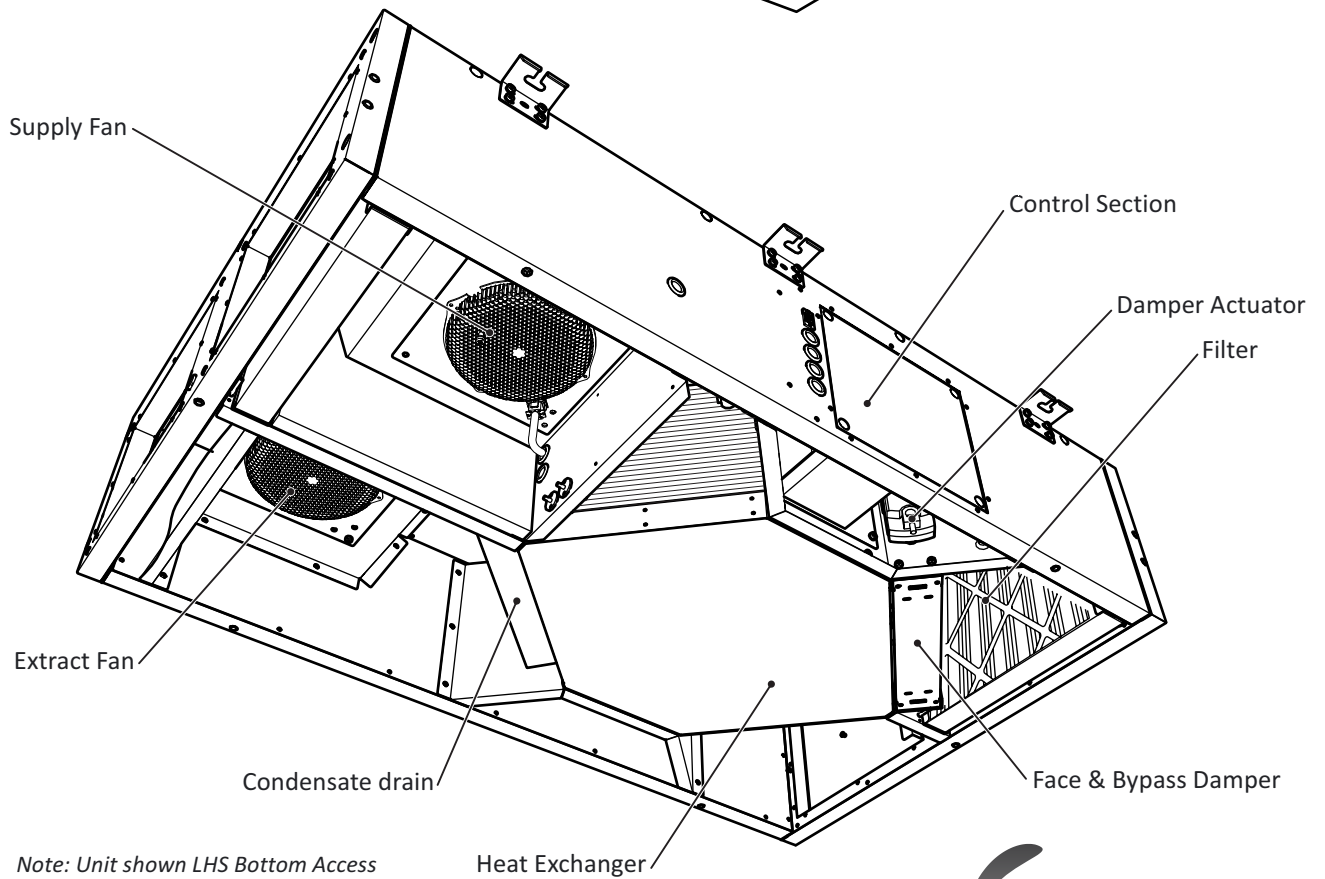

Note: Unit shown LHS Bottom Access

Maintenance 7 Continued

Important



ecovent® mini units feature a bulkhead-mounted fan plate assembly. Ensure that special care is taken when removing/replacing components/assemblies from bottom-access units. For larger components this may require the use of two or more persons. The mounting plate is slotted to aid plate alignment. It is important to keep the fan assembly supported at all times; the fan assembly should not be considered supported until all fixings are securely tightened.

ecovent® mini units sizes 1 and 2 feature a double inlet centrifugal fan mounted on an adapter plate. To remove, ensure the unit is fully isolated, unplug as per fig 13 undo the two screws and carefully remove the fan/adapter plate assembly, retaining all fixings. When replacing the fan assembly, ensure all fixings are reinstated and the plug connector is correctly reconnected.

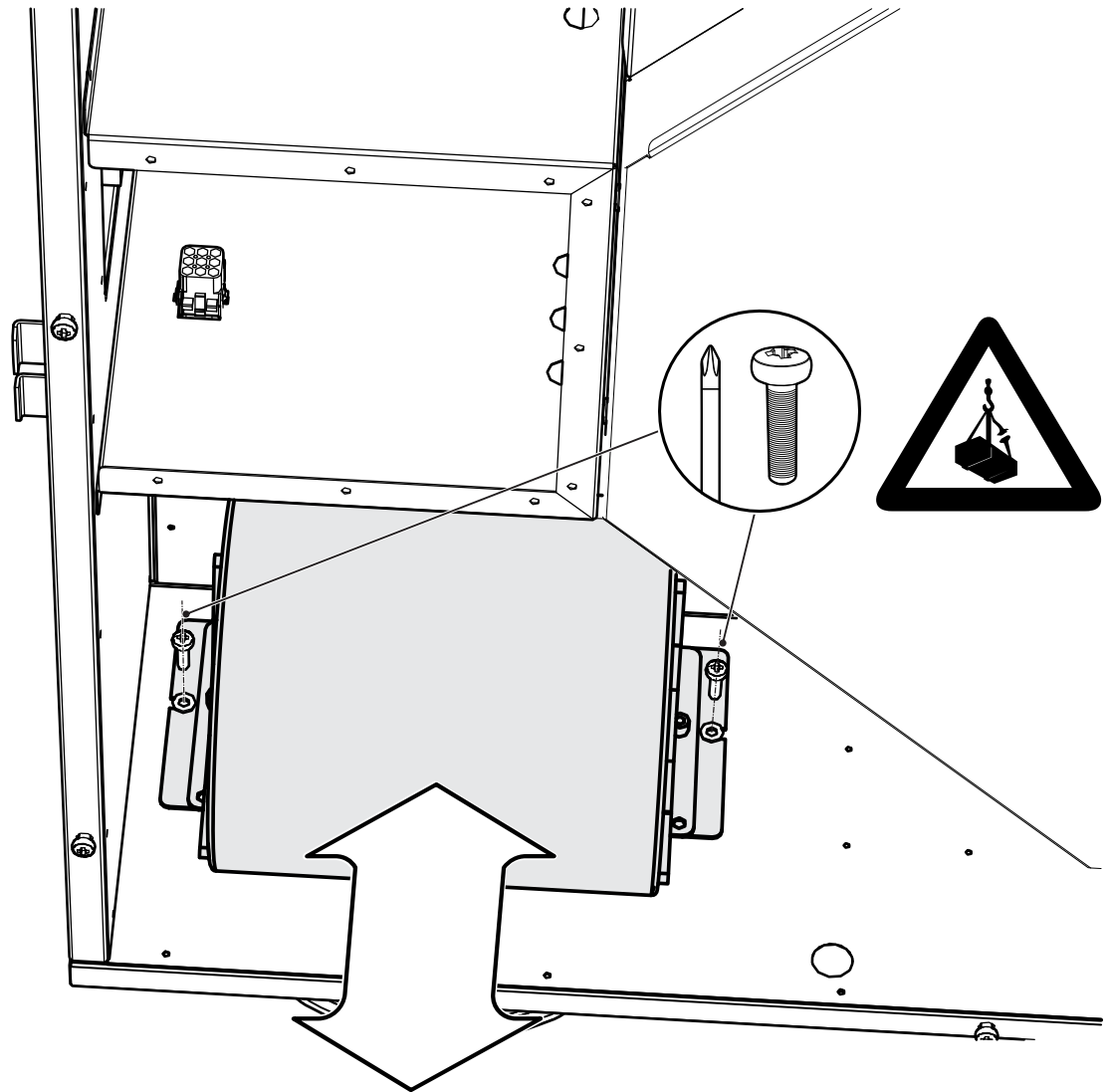

Fan removal
Fig. 16

Maintenance 7 Continued

Important



ecovent® mini units feature a bulkhead-mounted fan plate assembly. Ensure that special care is taken when removing/replacing components/assemblies from bottom-access units. For larger components this may require the use of two or more persons. It is important to keep the fan assembly supported at all times; the fan assembly should not be considered supported until all fixings are securely tightened.

ecovent® mini size 3 units feature a single inlet centrifugal fan mounted on a support assembly. To remove, ensure the unit is fully isolated, unplug as per fig 13 undo the four screws and carefully remove the fan/support assembly, retaining all fixings. When replacing the fan assembly, ensure all fixings are reinstated and the plug connector is correctly reconnected. The fan bulkhead cutout is handed to ensure correct orientation of the fan assembly within the unit. Ensure the connection socket on the fan plate is closest to the associated plug/flying lead.

Fan removal
Fig. 17

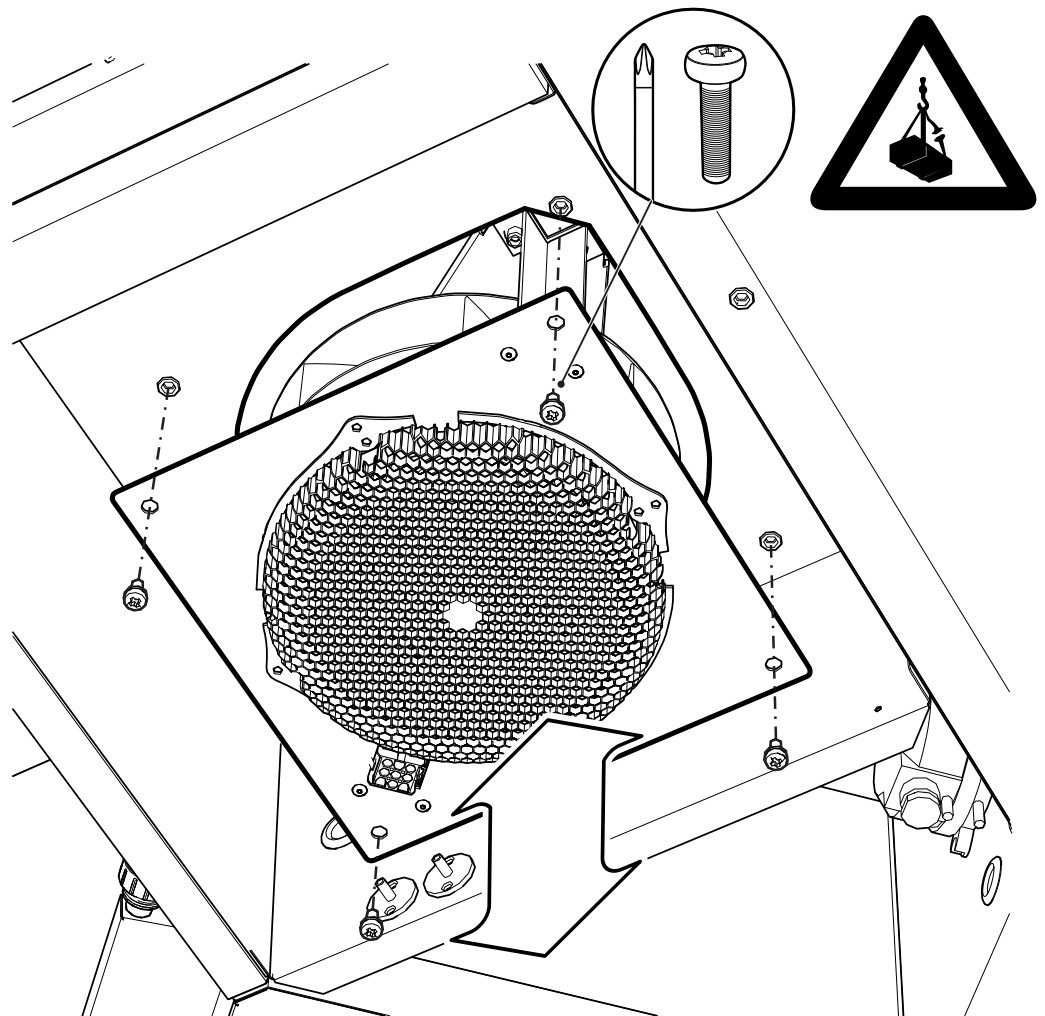

Maintenance 7 Continued

Recommended Checks In order to keep the unit in good order the following maintenance routine is recommended:

Three Monthly Checks Filters should be inspected every three months. If they are found to be heavily soiled or damaged in any way they should be replaced. Spare filters can be ordered from VES Spares Department. The filters may be accessed via dedicated access doors on the bottom of the unit. Tools should not be required for filter removal.

Caution  Filter doors are not self-supporting. Take care to support the doors during the removal process, ensure that the doors are replaced correctly and that **The Slide Catches Are Fully Engaged**. It is important to replace damaged catches, which can be ordered from VES Spares Department

Filter Panel Operation
Fig. 18

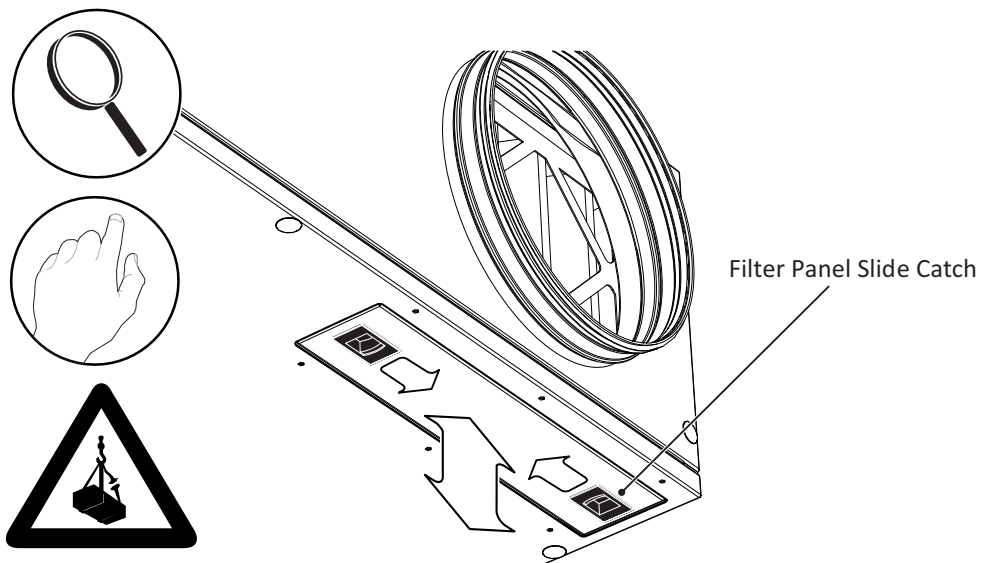

Filter Panel Operation
Fig. 19

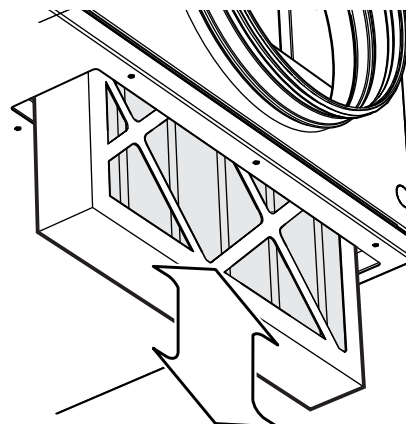

To replace, dispose of the old filters responsibly, note the airflow direction arrow on the new filter. Slide the clean filter into the unit and replace the filter doors. Take care to stow the support lead safely within the unit and ensure the filter door is correctly seated with **All The Slide Catches Fully Engaged**.

Maintenance
Six Monthly Checks

7

Continued

The fan impeller requires cleaning every six months. Neglecting regular cleaning may lead to a decrease in fan performance or cause it to become unbalanced. If a fan remains stationary for extended periods in a humid environment, it should be turned on for a minimum of two hours each month to eliminate any condensed moisture within the motor.

The fan motors are maintenance-free because they use ball bearings with "life-long lubrication." However, when the grease life of the bearings expires, it becomes necessary to either replace the bearings or the entire fan unit. The standard lifespan of bearings under normal usage conditions is approximately 30,000 to 40,000 hours.

Failure to maintain clean dampers could result in their malfunctioning. To prevent this, clean the damper blades and frames and lubricate them with PTFE aerosol or an equivalent lubricant. If it becomes necessary to remove the damper, follow a similar process as removing the heat exchanger: disconnect and remove the damper actuator, undo the two M6 fixings on either side of the assembly, and lower the damper out of the unit. When replacing the damper, ensure all fixings are properly reattached and the actuator is reconnected.

Inspect the heat exchanger matrix for debris, dust, or dirt buildup. If contamination is found, remove any foreign matter accordingly. Superficial dust or debris can be gently brushed off the heat exchange surface, and loosened debris can be vacuumed or flushed out with warm water. Stubborn deposits may require the use of a low-pressure washer with an approved detergent solution, ensuring that the solution temperature does not exceed 50 °C.

Take care not to damage the heat exchanger when using any pressure device.

Caution



Under NO circumstances should the heat exchanger be steam cleaned.

Should it be necessary to remove either drain or heat exchanger; ensure the drain is dry and empty. Disconnect the drain. **Ensure The Exchanger Assembly Remains Supported At All Times** Remove the four M6 fixings, two either side of the assembly as shown, and lower the heat exchanger assembly out of the unit. Ensure when replaced all fixings are returned.

Bypass/Heat exchanger removal

Fig. 20

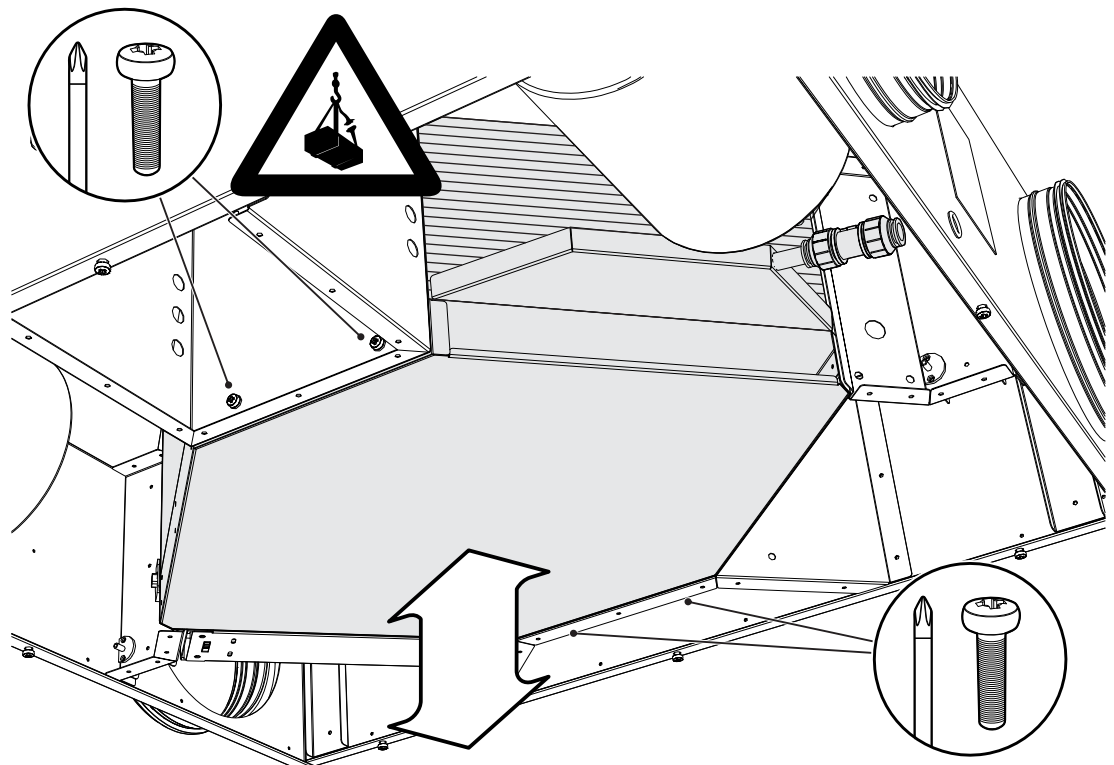

Maintenance 7 Continued

Please ensure that the drain pan and drain connection are clear of debris so that any condensate produced can freely drain away. If a pump is installed, inspect the sensor and float for contamination and clean them if necessary using a 95/5% water/chlorine solution. Also, inspect all associated pipework and replace any damaged or blocked pipes. Spare replacement pipes can be obtained from VES.

If a comprehensive service is needed, it may be necessary to dismantle the unit's casework to access certain components. If it is necessary to remove the damper, follow these steps: unscrew the spindle that holds it in place on the blade, slide the spindle/actuator out from the damper, and then remove the damper side fixings.

Twelve Monthly Checks

ecovent® *mini* units are supplied with a powdercoat paint finish as standard. Check all painted items to ensure that they have not deteriorated, particularly where adverse environmental conditions prevail. Re-paint as necessary. Matching paint can be supplied upon request.

Spares & Repairs

When enquiring after or ordering spares contact VES Spares Department, quoting the sales order (SO) number and unit type as found on the unit nameplate.

Tel: 02380 461150

Spare Parts List

Fig. 21

Part Number	Part Description
ZG0301/43/50	Fan Assembly (size 1& 2)
ZE0331/47/30	Fan Assembly (size 3)
GSD141.1A	Damper Actuator
EVCMDF100	Size 1 Filter G4
EVCMDF200	Size 2 Filter G4
EVCMDF300	Size 3 Filter G4
EVCMPF100	Size 1 Filter F7 (Optional)
EVCMPF200	Size 2 Filter F7 (Optional)
EVCMPF300	Size 3 Filter F7 (Optional)
PSGN1012	Filter Pressure Switch
FX001007	Filter Door Slide Latch
FX002404	ø15.9mm Hole Domed Cover Cap
ELEX2010/0250	Filter Door Restraint

WEEE Directive



At the end of their useful life the packaging and product should be disposed of via a suitable recycling centre. Do not dispose of with normal household waste. Do not burn.

PLEASE ENSURE THAT THIS DOCUMENT IS PASSED ON TO THE END USER



Counterflow Heat Recovery Units

Operation & Maintenance Manual

©VES Andover Ltd. 2024
VES is a trading name of VES Andover Ltd.
Registered in England No. 02303719.
Registered Office as above.



Eagle Close, Chandlers Ford Industrial Estate, Chandlers Ford, Eastleigh, Hampshire, SO53 4NF
Tel: +44 (0) 2380 46 11 50 email: info@ves.co.uk web: www.ves.co.uk