

CENTRIFUME

The Kitchen Extract Fan Range



**Roof and Duct
Mounting Units**

**For High Temperature
Polluted Air**

**Volumes from
0.2 to 9.5m³/sec**

Unique Design Features

With



You Breathe Easy



Model CFR Unit

Centrifume

The Centrifume fans have been designed to meet the arduous conditions found in restaurant kitchen hood extract systems - hot air with high grease content.

The Centrifume is also suitable for many other air extract systems providing a wide range of volume and pressure options plus low speeds for super-quiet requirements.

The Centrifume sets industry standards with superior design and engineering build quality.

Look at these Features:

- Maximum continuous operating air temperature 190°C.
- The motor and drive completely out of the airstream, with motor cooling ducted from atmosphere.
- Two types of impeller are offered, Standard (STD) and High Pressure (HP). When making selection, check fan speed, motor power and noise levels for best selection.
- Very low noise levels achievable within occupied zone.
- The outlet velocities can be selected to ensure that contaminants are discharged well clear of surroundings.
- The cases are leakproof and heavily built of rolled aluminium. A bird screen is fitted within the windband. The cases can be supplied with powder coated finish if required, standard colour light grey to BS 00A05, other colours available.
- The motor and drive is easily accessible for maintenance via the removable cover.
- Grease, water and any other liquid effluent drain to the base of the roof unit for collection in the optional drain trough.
- All units have been tested to AMCA procedures, providing certified air performance and sound levels.
- Ancillaries include profiled soaker sheet bases for the roof units and backdraught shutters for mounting in the duct before the unit.
- Also available on CFR roof units:
 - 75mm diameter clean out port on windband adjacent to impellor.
 - Hinge kit up to size CFR 240 to enable access to top of duct.



CFR unit with fitted grease trough.

Unit Components

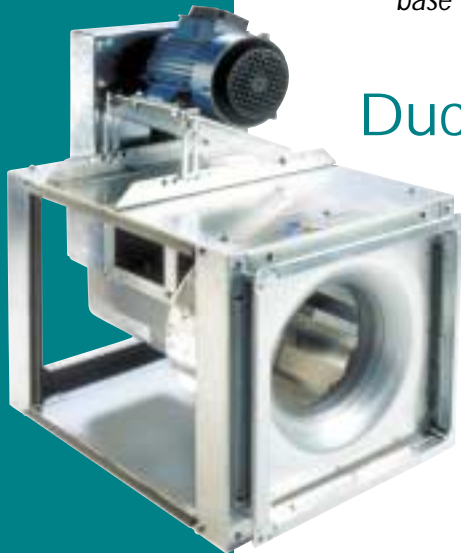
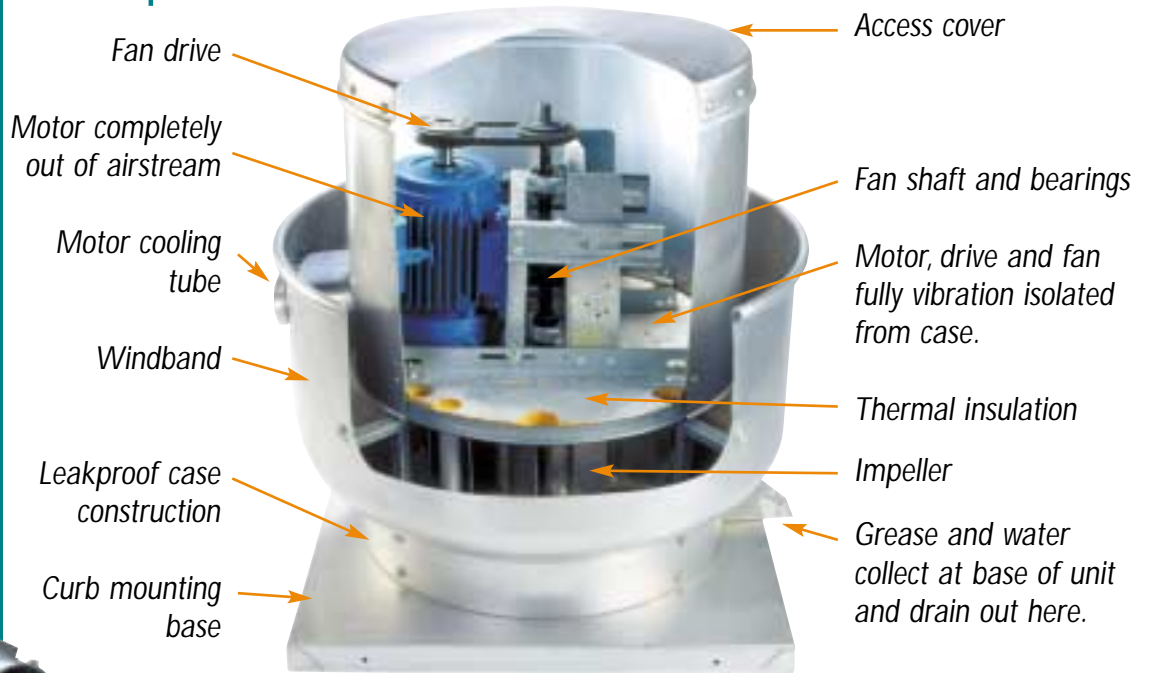

Duct Mounting Unit

The CFD is a duct mounting unit with motor out of airstream. The backward curved impeller is mounted in a single skinned square housing. A grease collection tray can be fitted into the unit if required. The duct mounting case can be fitted with an external acoustic cladding to minimise noise breakout. Weatherproof housing with acoustic lining also available.



Weatherproof housing

Go to pages 13-22 for details, dimensions, and selections.

Silencers

- A range of **unique cleanable silencers** is available for all units. A removable side panel reveals the acoustic splitters which can be withdrawn for cleaning with steam or power washer. The splitters contain resin bonded mineral wool slab that has been heat shrink sealed into polythene enclosures, and fitted into modules of perforated galvanised sheet steel. These are completely waterproof.
- The silencers have been designed for duct mounting in horizontal or vertical mode and the removable access panel can be positioned on side, top or bottom as required.
- Silencers are also available in non-cleanable construction for uncontaminated extract systems. Selection details on page 23.



Silencer with side removed

Technical Details

0.18kw and 0.25kw motors are supplied single phase as standard, and up to 1.5kw motors are also available in 230 volt single phase. In 415 volt three phase both single and two speed motors are available. All units can be supplied with an inverter for fan speed control. For details of motors, inverter control, isolators and starters see page 24. Run and standby motors can be supplied in the larger case sizes. The CFR roof unit motor is prewired to a fitted local isolator.

The fan has an aluminium backward curved non-overloading centrifugal impeller. The drive shaft bearings have a life expectancy in excess of 100,000 hours, and on the CFR roof units, the drive assembly is fully vibration isolated from the case.

The impeller is spark proof and a flameproof motor can be supplied.

The single figure noise levels SPL dBA are the sound pressure levels at 3.0 metres from the unit.

To select the unit you require:

The fan performance data for the CFR roof units are detailed on pages 4 to 11.

The duct mounted units model CFD have fan performance selections on pages 14 to 17.

When selecting a unit compare noise levels for different sizes and speeds if sound level is an important consideration.

The sound spectrum stated is for a selection at the mid-duty point of the fan curve, the sound level at your actual duty point will be advised on your quotation or on request.

Specify the unit details:

Model	CFR	140	-	HP	/	1500 RPM	/	3 Phase.
	Roof or Duct Unit	Size		Standard or High Pressure Unit		Fan Speed		Motor Voltage

And note any other requirements-

- Fitted isolator.
- Drain trough for grease collection.
- Two speed motor.
- Fan Speed control with inverter.
- Powder coated case finish.
- Duct mounting backdraught shutters.
- Soaker sheet base - state roof profile, and angle of roof.
- Silencer to suit.

CFR 100 - STD

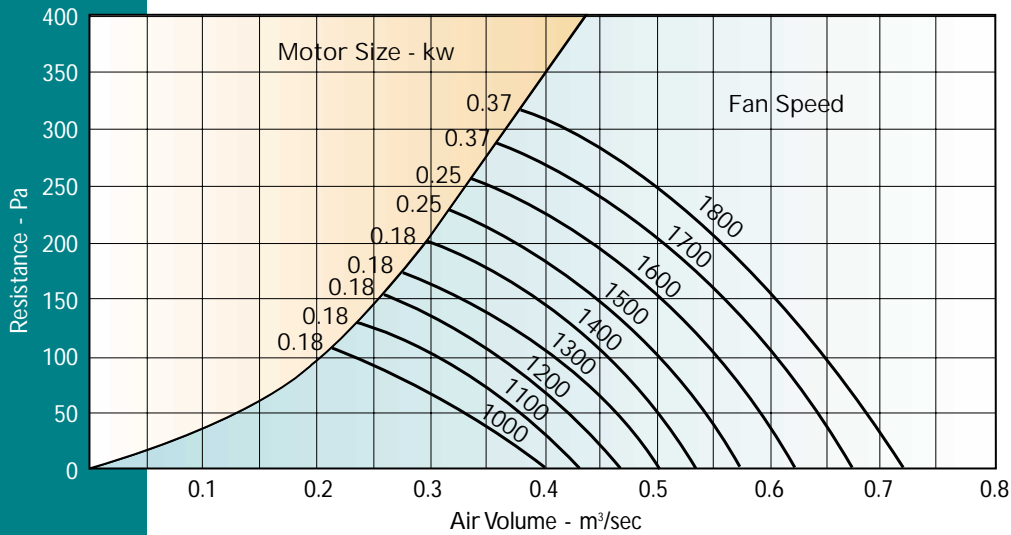

Unit
Dimensions
Page 12

Model 100 - STD	Sound Power Level Spectrum dB re10 ⁻¹² w. PWL								SPL dBA @3.0m
	Centre Frequency - Hz								
Fan Speed	63	125	250	500	1K	2K	4K	8K	
1000	67	66	66	57	51	49	44	37	44
1100	65	69	68	59	54	52	47	41	46
1200	66	70	70	61	57	55	50	44	48
1300	66	69	71	62	57	56	51	45	49
1400	69	70	74	64	60	59	54	48	51
1500	73	71	77	67	62	63	57	51	54
1600	74	72	77	68	62	63	58	52	55
1700	73	73	78	71	64	65	59	53	56
1800	71	74	77	72	64	65	60	54	56

CFR 100 - HP

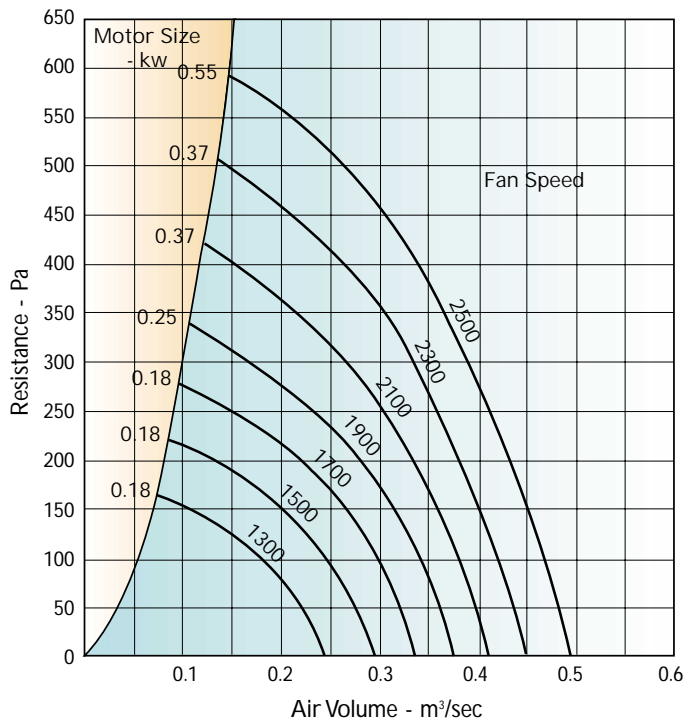

MAKE SELECTION

Model 100 - HP	Sound Power Level Spectrum dB re10 ⁻¹² w. PWL								SPL dBA @3.0m
	Centre Frequency - Hz								
Fan Speed	63	125	250	500	1K	2K	4K	8K	
1300	79	72	61	52	57	52	44	40	45
1500	79	73	66	62	61	58	53	50	50
1700	80	76	69	66	64	60	55	51	52
1900	83	79	71	71	68	62	58	55	56
2100	81	80	72	73	69	63	59	56	57
2300	79	80	71	73	69	65	61	59	59
2500	79	78	71	75	70	68	63	63	59

CFR 120 - STD

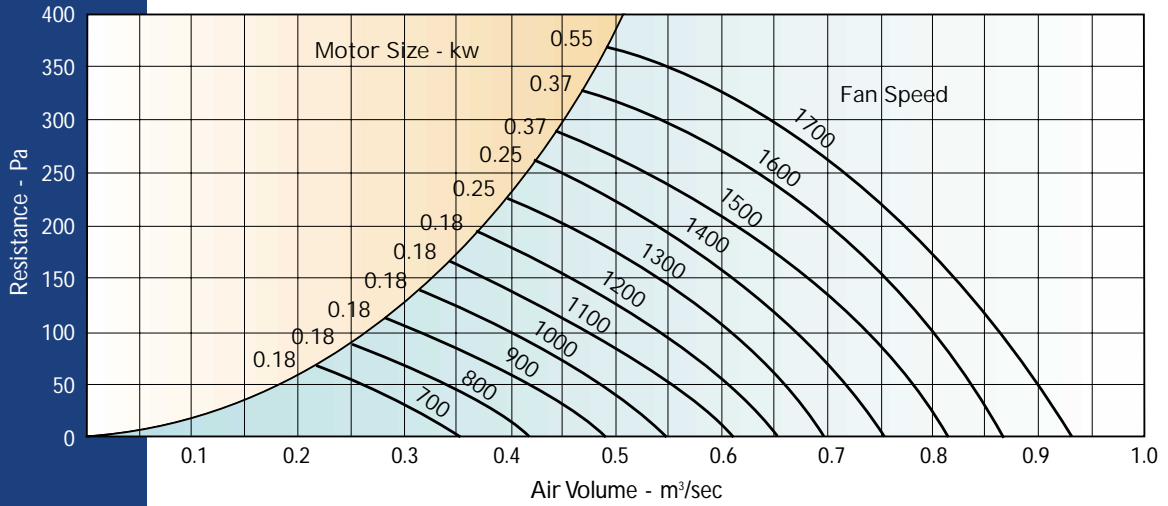

Model 120 - STD	Sound Power Level Spectrum dB re10 ⁻¹² w. PWL								SPL dBA @3.0m
	Centre Frequency - Hz								
Fan Speed	63	125	250	500	1K	2K	4K	8K	
700	71	66	62	53	51	51	39	36	42
800	71	67	65	55	53	53	42	37	44
900	70	68	67	57	54	55	44	39	46
1000	70	70	69	59	56	57	46	40	48
1100	70	71	71	61	58	59	49	41	50
1200	73	74	75	64	60	61	52	44	53
1300	75	76	79	66	62	63	54	46	56
1400	76	78	82	68	64	65	56	48	58
1500	78	79	84	70	65	66	58	50	60
1600	80	80	86	72	67	67	61	53	63
1700	81	81	89	74	69	68	63	55	65

CFR 140 - STD

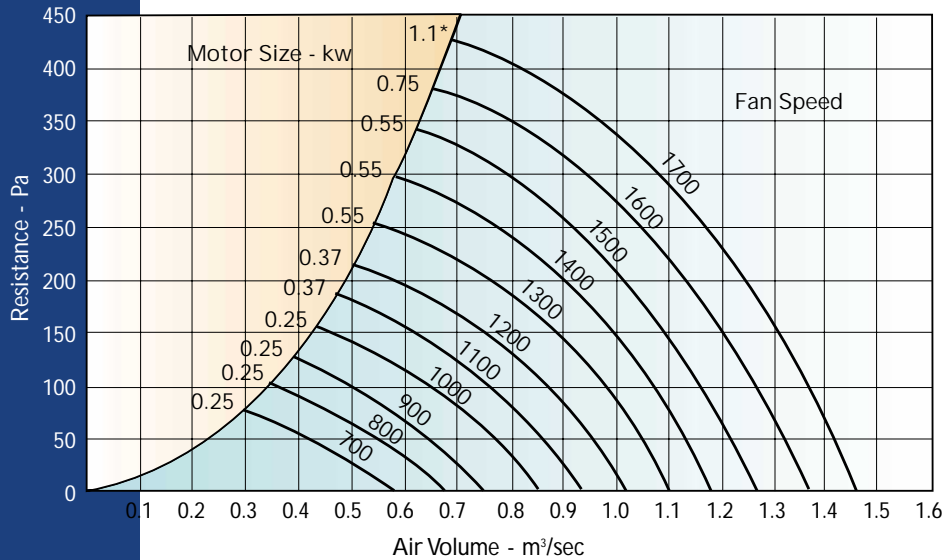

Unit
Dimensions
Page 12

* Not available with 230 volt 1 phase motor.

Model 140 - STD	Sound Power Level Spectrum dB re10 ⁻¹² w. PWL								SPL dBA @3.0m
	Centre Frequency - Hz								
Fan Speed	63	125	250	500	1K	2K	4K	8K	
700	69	71	59	54	59	46	39	30	44
800	68	74	62	57	60	50	42	35	47
900	68	76	65	60	61	54	46	40	48
1000	69	78	69	64	62	59	50	45	47
1100	69	80	73	67	62	63	54	49	54
1200	71	80	75	69	64	65	56	51	56
1300	72	80	78	71	65	68	59	53	58
1400	72	78	78	72	65	64	59	54	57
1500	72	75	80	75	67	59	61	56	59
1600	73	63	85	77	68	55	61	59	62
1700	73	64	85	79	69	50	63	60	63

CFR 160 - STD

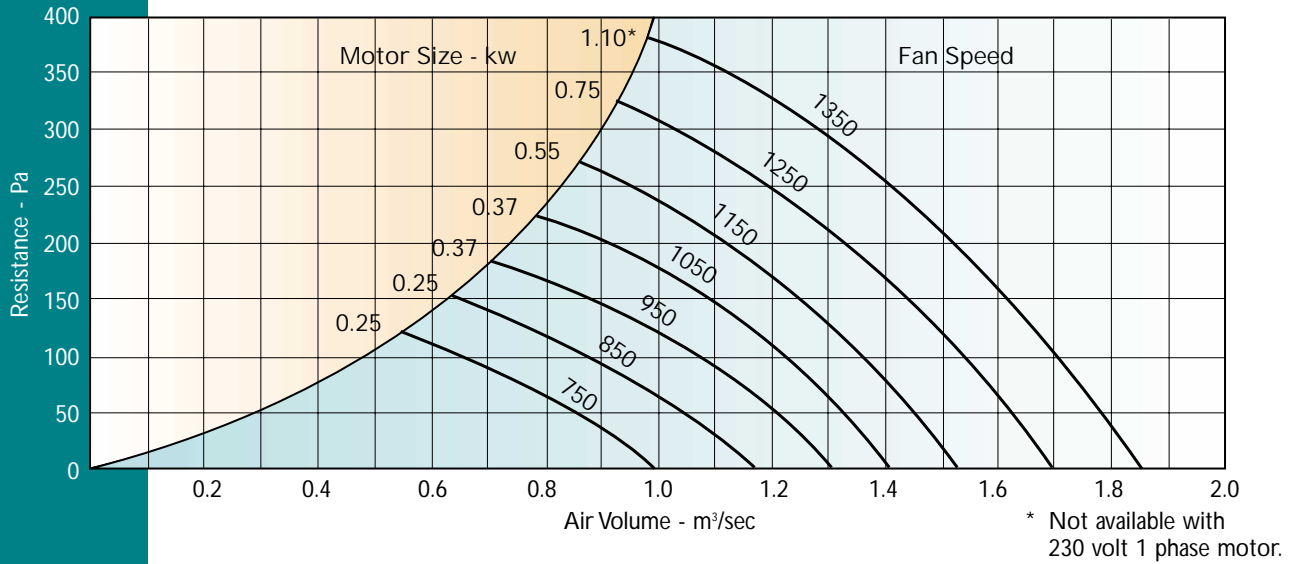

Model 160 - STD	Sound Power Level Spectrum dB re10 ⁻¹² w. PWL								SPL dBA @3.0m
	Centre Frequency - Hz								
Fan Speed	63	125	250	500	1K	2K	4K	8K	
750	68	74	68	63	63	59	53	48	51
850	70	76	71	67	65	62	56	51	54
950	72	78	74	71	67	64	59	55	56
1050	73	79	76	73	68	66	61	57	58
1150	74	79	78	76	70	67	64	60	60
1250	75	80	80	78	72	69	66	63	62
1350	76	82	83	81	73	72	68	66	65

CFR 160 - HP

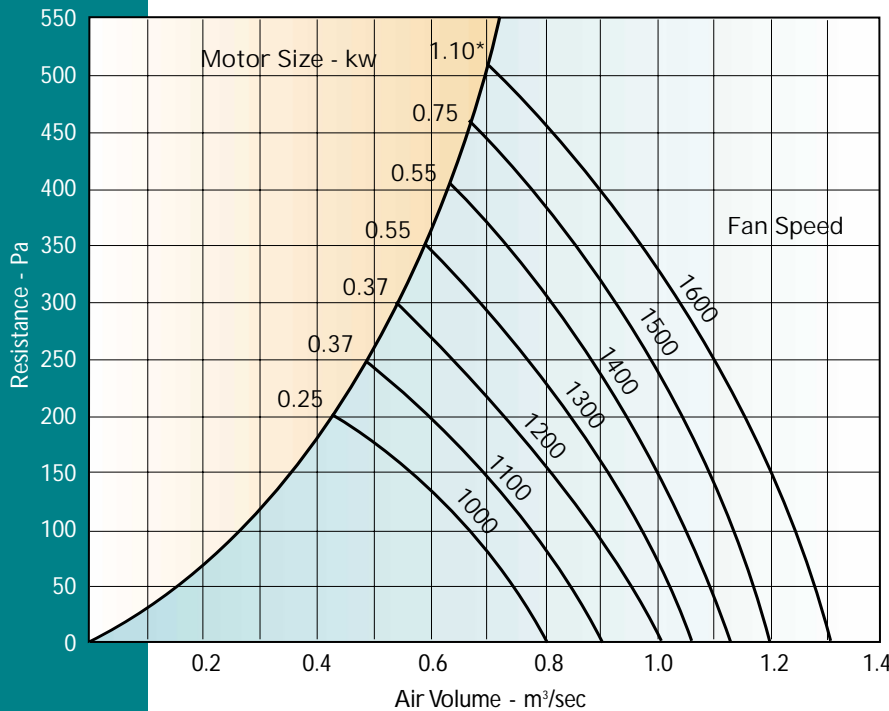

* Not available with 230 volt 1 phase motor.

MAKE SELECTION

Model 160 - HP	Sound Power Level Spectrum dB re10 ⁻¹² w. PWL								SPL dBA @3.0m
	Centre Frequency - Hz								
Fan Speed	63	125	250	500	1K	2K	4K	8K	
1000	72	77	74	67	62	62	56	48	53
1100	72	80	77	70	64	64	60	53	56
1200	73	79	78	72	66	66	64	56	58
1300	74	74	77	73	68	67	66	59	59
1400	76	75	79	73	69	69	68	62	60
1500	77	76	81	73	69	70	69	63	61
1600	79	77	85	74	72	72	73	67	64

CFR 180 - STD

Unit
Dimensions
Page 12

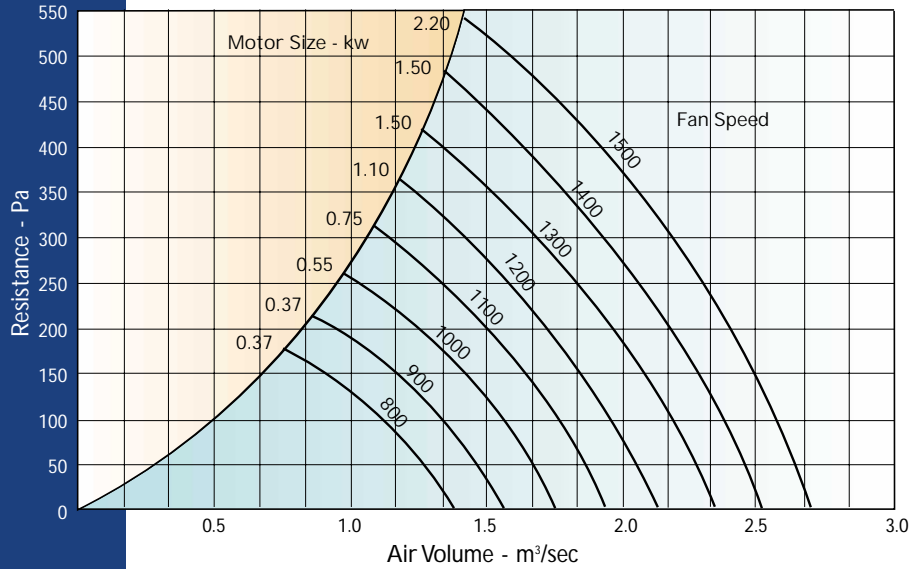

Model 180 - STD	Sound Power Level Spectrum dB re10 ⁻¹² w. PWL								SPL dBA @3.0m
	Centre Frequency - Hz								
Fan Speed	63	125	250	500	1K	2K	4K	8K	
800	70	78	73	65	61	60	53	45	53
900	72	80	78	69	64	64	57	51	56
1000	75	79	82	74	67	71	62	54	61
1100	76	80	84	75	68	71	64	56	62
1200	78	80	85	75	69	69	65	57	63
1300	78	81	86	77	72	70	66	61	64
1400	80	83	89	79	74	73	68	65	67
1500	81	84	91	81	77	75	70	69	69

CFR 180 - HP

MAKE SELECTION

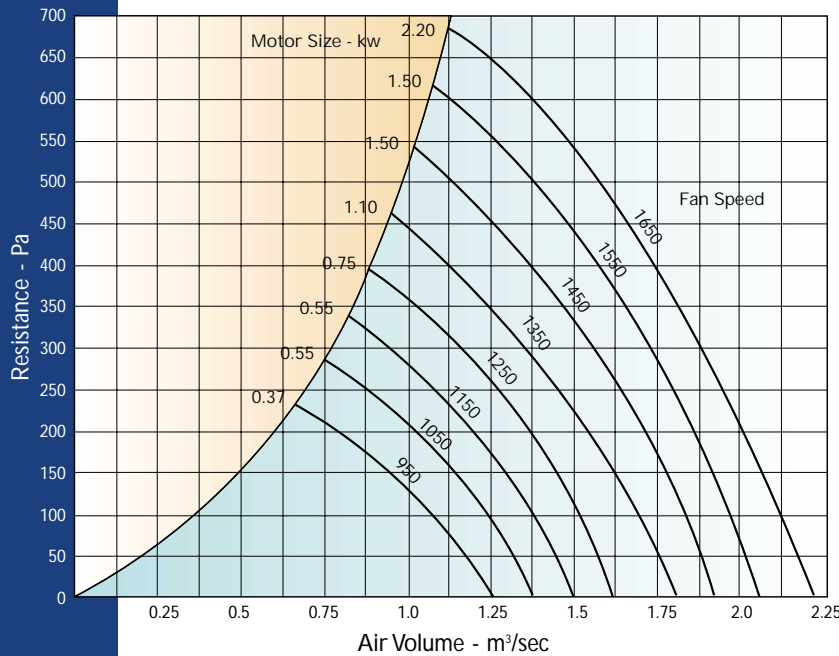

Model 180 - HP	Sound Power Level Spectrum dB re10 ⁻¹² w. PWL								SPL dBA @3.0m
	Centre Frequency - Hz								
Fan Speed	63	125	250	500	1K	2K	4K	8K	
950	81	78	77	70	61	60	55	51	55
1050	84	78	79	74	65	63	59	54	58
1150	82	77	81	74	68	66	61	56	59
1250	78	76	83	72	69	68	63	58	61
1350	79	78	86	75	72	71	67	61	64
1450	81	80	88	79	75	74	70	64	66
1550	84	80	88	82	75	74	71	65	67
1650	88	81	88	85	75	74	72	67	68

CFR 200 - STD

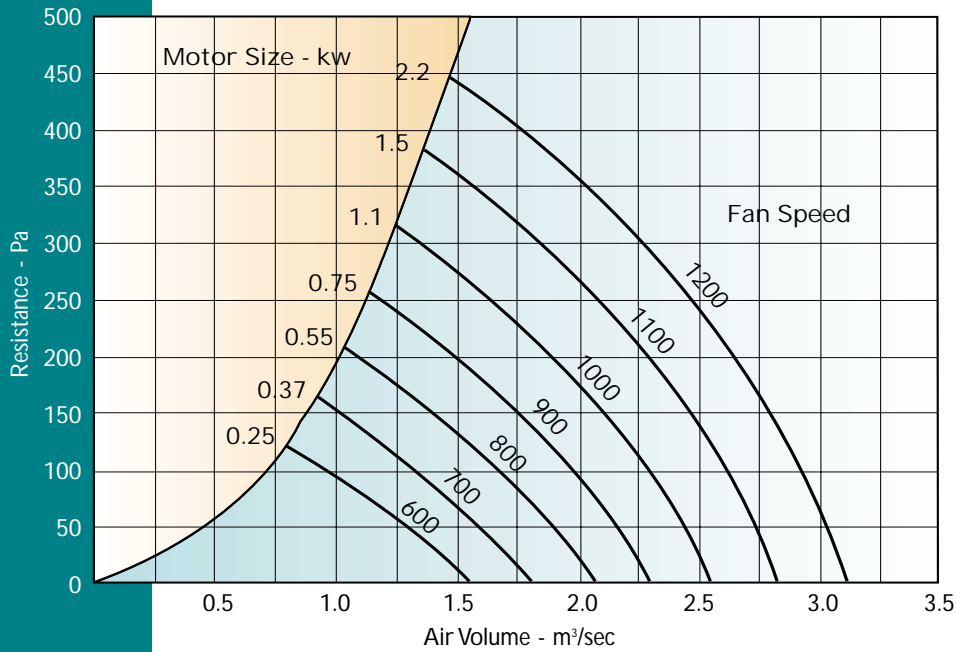

Model 200 - STD	Sound Power Level Spectrum dB re10 ⁻¹² w. PWL								SPL dBA @3.0m
	Centre Frequency - Hz								
Fan Speed	63	125	250	500	1K	2K	4K	8K	
600	70	72	68	61	56	54	48	41	47
700	72	76	73	66	59	59	53	46	52
800	75	81	78	71	62	63	57	51	57
900	78	83	80	72	65	65	60	54	59
1000	77	82	85	76	68	68	64	58	62
1100	78	82	89	79	71	71	67	62	66
1200	87	83	88	79	73	73	69	64	66

CFR 200 - HP

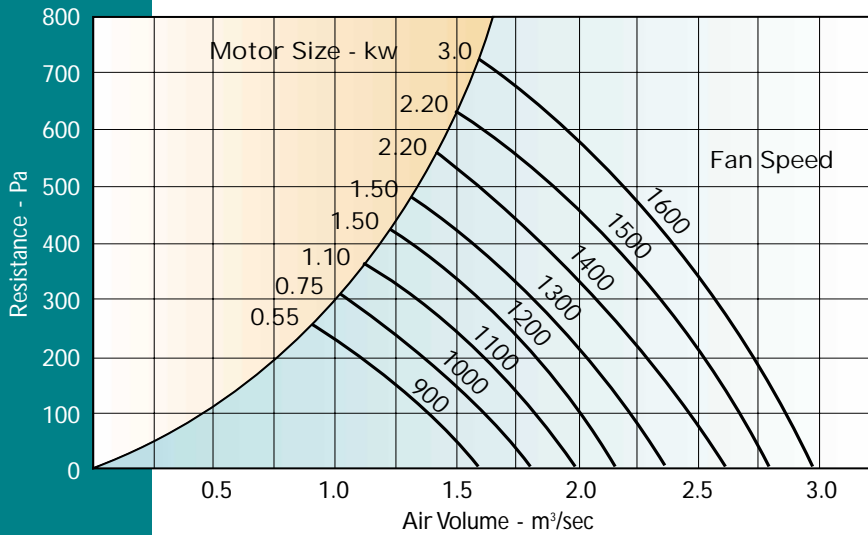

Model 200 - HP	Sound Power Level Spectrum dB re10 ⁻¹² w. PWL								SPL dBA @3.0m
	Centre Frequency - Hz								
Fan Speed	63	125	250	500	1K	2K	4K	8K	
900	73	76	75	71	63	62	58	52	55
1000	75	76	79	78	67	66	62	56	61
1100	77	77	82	80	71	69	65	59	63
1200	79	80	85	80	74	72	67	62	65
1300	81	82	87	79	77	74	70	65	66
1400	80	80	88	81	79	76	71	67	68
1500	80	79	89	83	81	78	73	69	69
1600	82	78	95	84	82	79	74	72	73

MAKE SELECTION

MAKE SELECTION

CFR 240 - STD

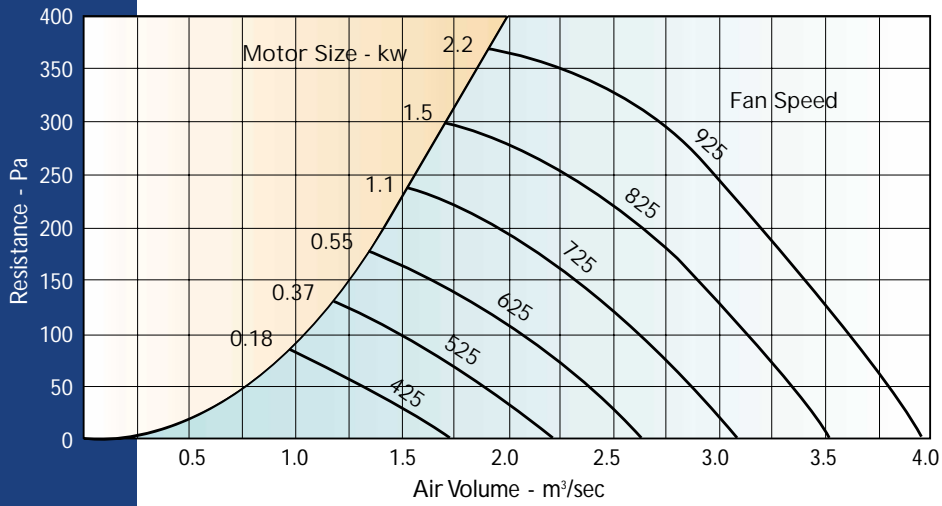

Model 240 - STD	Sound Power Level Spectrum dB re10 ⁻¹² w. PWL								SPL dBA @3.0m
	Centre Frequency - Hz								
Fan Speed	63	125	250	500	1K	2K	4K	8K	
425	69	71	62	61	58	50	42	36	46
525	70	76	69	65	62	56	48	41	51
625	72	80	73	67	66	60	52	46	54
725	75	84	77	70	69	64	57	52	59
825	79	86	82	75	73	68	61	56	62
925	80	86	86	78	75	71	64	59	65

CFR 240 - HP

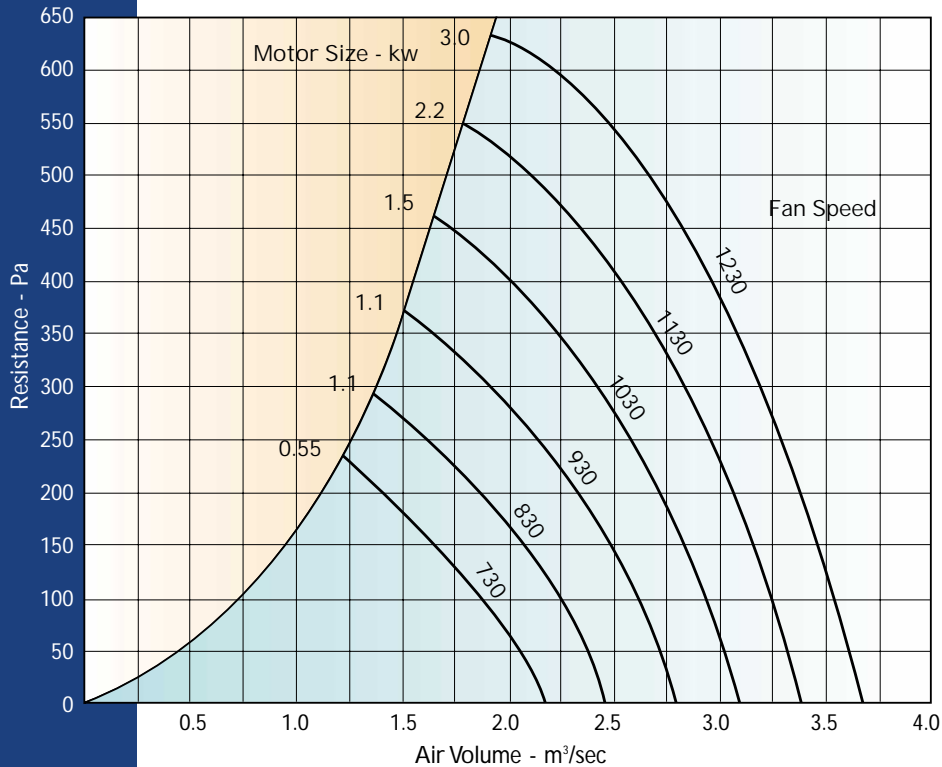

Model 240 - HP	Sound Power Level Spectrum dB re10 ⁻¹² w. PWL								SPL dBA @3.0m
	Centre Frequency - Hz								
Fan Speed	63	125	250	500	1K	2K	4K	8K	
730	72	81	77	69	63	61	55	51	56
830	74	83	80	73	67	65	59	55	60
930	77	82	83	76	71	69	63	59	62
1030	79	82	86	79	74	72	67	63	65
1130	81	83	89	87	77	75	69	67	68
1230	80	81	91	82	76	75	69	68	69

MAKE SELECTION

CFR 300 - STD

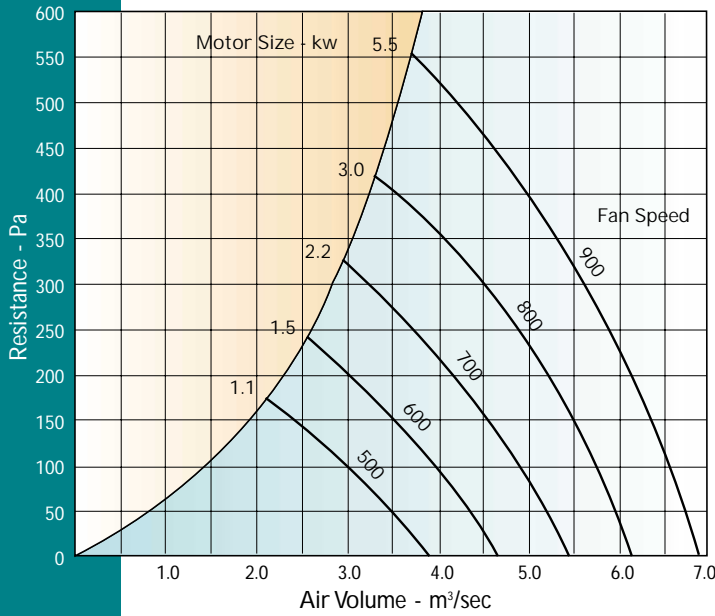

Unit
Dimensions
Page 12

MAKE SELECTION

Model 300 - STD	Sound Power Level Spectrum dB re10 ⁻¹² w. PWL								SPL dBA @3.0m
	Centre Frequency - Hz								
Fan Speed	63	125	250	500	1K	2K	4K	8K	
500	78	79	71	65	62	59	62	49	53
600	77	84	79	72	70	66	59	54	59
700	80	80	79	72	68	66	64	60	58
800	82	82	83	76	71	70	68	64	63
900	83	85	89	81	76	74	72	68	67

CFR 300 - HP

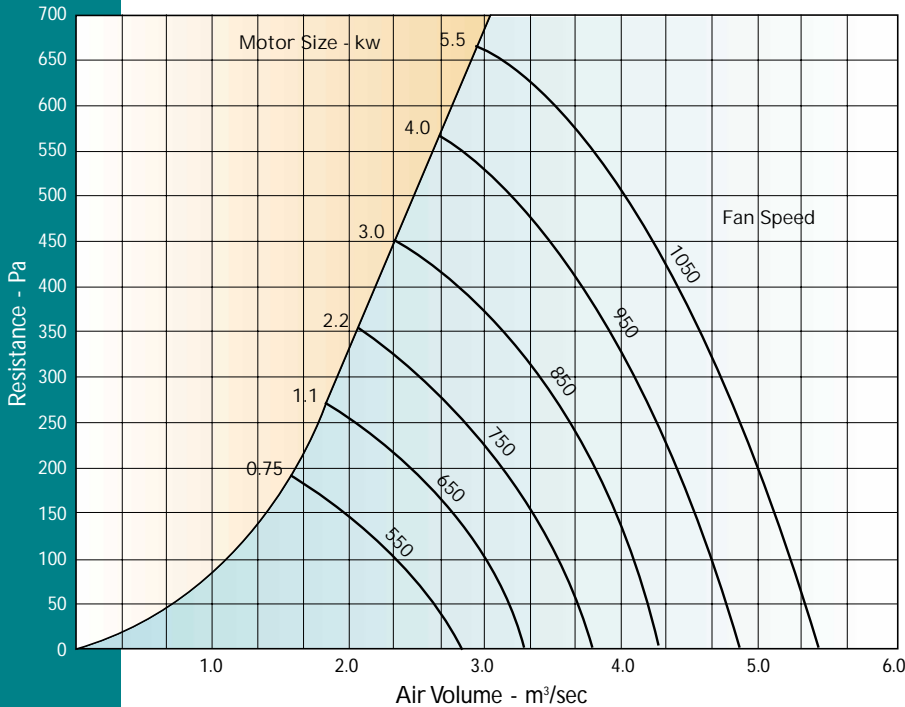

Model 300 - HP	Sound Power Level Spectrum dB re10 ⁻¹² w. PWL								SPL dBA @3.0m
	Centre Frequency - Hz								
Fan Speed	63	125	250	500	1K	2K	4K	8K	
550	74	77	74	68	64	65	60	51	55
650	76	82	78	73	67	67	64	56	60
750	78	84	82	77	71	70	68	60	63
850	82	86	86	82	77	76	73	66	67
950	85	87	90	86	80	79	77	70	71
1050	87	88	93	90	83	81	79	74	74

MAKE SELECTION

CFR 360 - HP

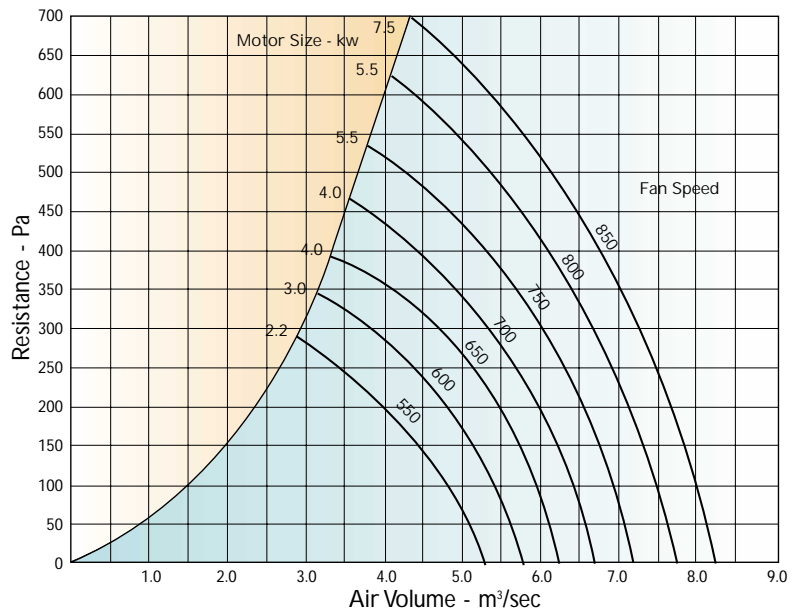

Model 360 - HP	Sound Power Level Spectrum dB re10 ⁻¹² w. PWL								SPL dBA @3.0m
	Centre Frequency - Hz								
Fan Speed	63	125	250	500	1K	2K	4K	8K	
550	84	89	82	73	70	66	59	54	62
600	83	89	83	75	72	67	61	55	63
650	83	90	84	77	74	69	64	59	64
700	84	92	84	78	75	71	66	61	65
750	86	95	85	79	78	73	67	63	67
800	87	95	88	81	80	74	70	65	69
850	88	96	91	83	82	77	72	68	71

Model CFR - Roof Extract Unit - Dimensions

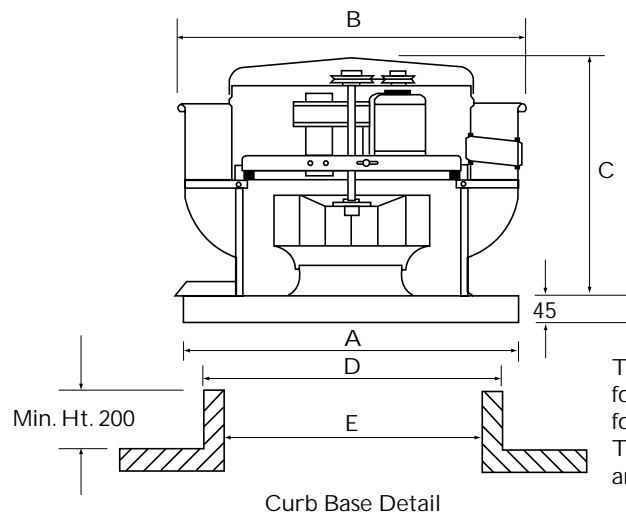

The CFR unit must be fitted onto a horizontal curb. If profiled soaker sheet base is required advise angle of roof so that transition can be supplied.

The dimension 'D' stated for the curb upstand allows for roof covering and flashing. The curb height allows for water and grease collection vessel.

CFR Model	Dimensions - mm					Weight Kgs*
	A	B	C	D	E	
100-STD 100-HP 120-STD	483	630	762	445	345	26 30
140-STD 140-HP 160-STD 160-HP	558	730	800	520	420	38 39
180-STD 180-HP 200-STD 200-HP	760	900	815	720	570	57 64
240-STD 240-HP	860	1085	950	820	670	79
300-STD 300-HP	1010	1270	1016	970	820	142
360-HP	1168	1490	1095	1125	975	200

* Weight varies with motor size.

Duct Mounting Range - Model CFD

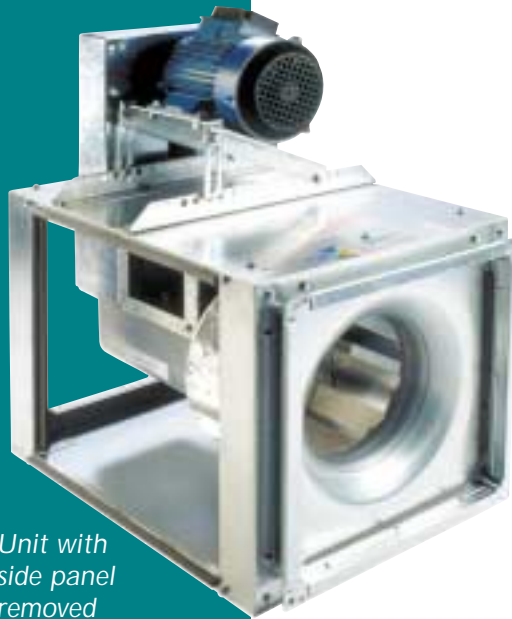

Unit with side panel removed

- For horizontal or vertical airflow, the unit case is flush panel single skinned with backward curved centrifugal non-overloading impeller, and motor and drive out of airstream.
- Because the motor is out of airstream the casing is very compact in size relation to the amount of air passed.
- When mounted horizontally the unit can be fitted with an integral grease collection tray and drain.
- The motor can be located on the top, side, or below the unit.
- Single or two speed motors can be fitted, and inverter fan speed control is available for most units.
- Run and standby motors can be fitted.

- The case is ruggedly constructed to maintain the alignment of the rotating parts. Easy access is provided for inspection and service and cleaning via removable side panels. The motor, drive, impeller, shaft and bearings can all be serviced without disturbing the duct mounting housing.

- The standard case construction is galvanised sheet steel. This can be powder coated if required. The case can also be fitted with an effective external acoustic cladding, comprising 25mm thick foam with sandwiched noise barrier layer and reinforced aluminium foil outer skin.

- A belt drive guard is fitted as standard.

- The drive shaft is ground and polished steel, mounted in heavy duty pillar block bearings.

- The unit is fitted with MEZ flanges for ductwork connection.

- Flexible connections, mounting feet and anti-vibration mounts are available.

- A weatherproof housing can be supplied, complete with acoustic lining, fitted silencers, outlet cowl and channel base. Standard colour light grey to BS00A05.

- Sound breakout noise levels are available for duct mounting and weatherproof units.



Unit with side panel removed showing impeller and drive guard



Unit in weatherproof housing.

CFD 80 - STD

Unit Dimensions
Page 21

MAKE SELECTION

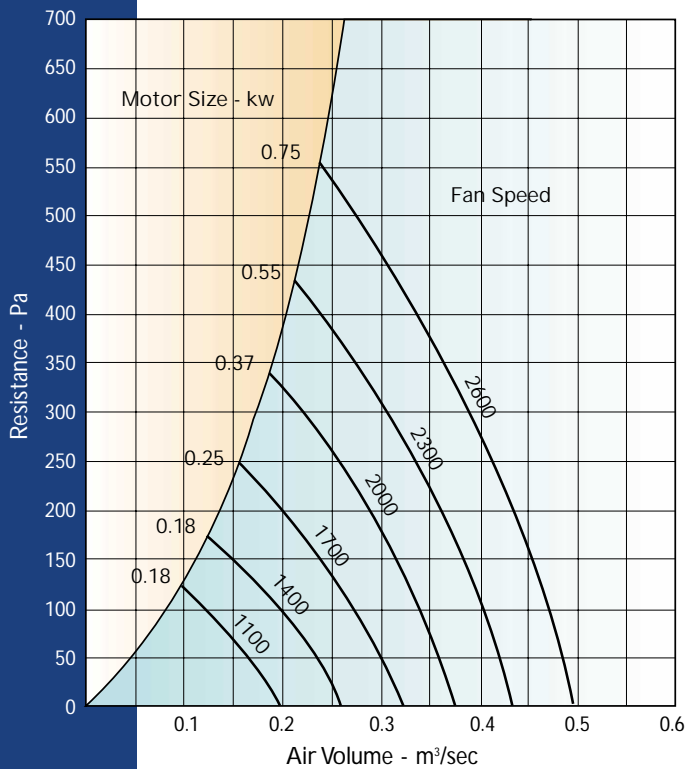

Model 80 - STD	Sound Power Level Spectrum dB re10 ⁻¹² w. PWL								SPL dBA @3.0m
	Centre Frequency - Hz								
Fan Speed	63	125	250	500	1K	2K	4K	8K	
1100	79	78	65	62	54	52	46	41	49
1400	79	81	72	70	60	57	55	49	54
1700	79	84	77	77	66	62	62	57	60
2000	80	85	78	83	72	66	66	65	65
2300	83	88	81	86	75	70	69	66	67
2600	87	91	84	89	78	73	72	68	70

CFD 100 - STD

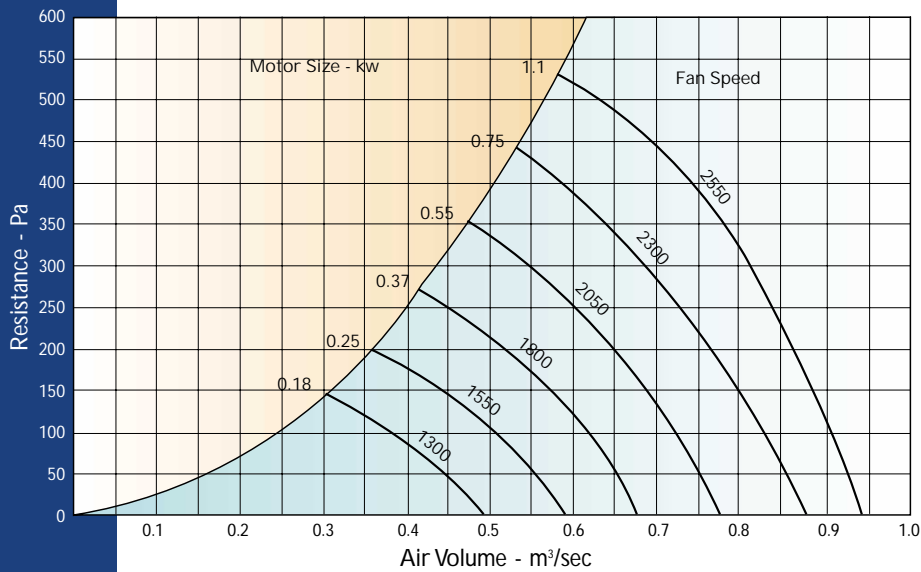

Model 100 - STD	Sound Power Level Spectrum dB re10 ⁻¹² w. PWL								SPL dBA @3.0m
	Centre Frequency - Hz								
Fan Speed	63	125	250	500	1K	2K	4K	8K	
1300	77	75	72	63	55	56	49	44	50
1550	78	83	76	74	63	60	59	52	57
1800	78	84	78	80	69	64	64	60	62
2050	79	86	81	83	74	68	68	68	66
2300	84	87	80	85	74	69	68	66	67
2550	86	89	83	88	76	72	70	68	69

CFD 140 - STD

MAKE SELECTION

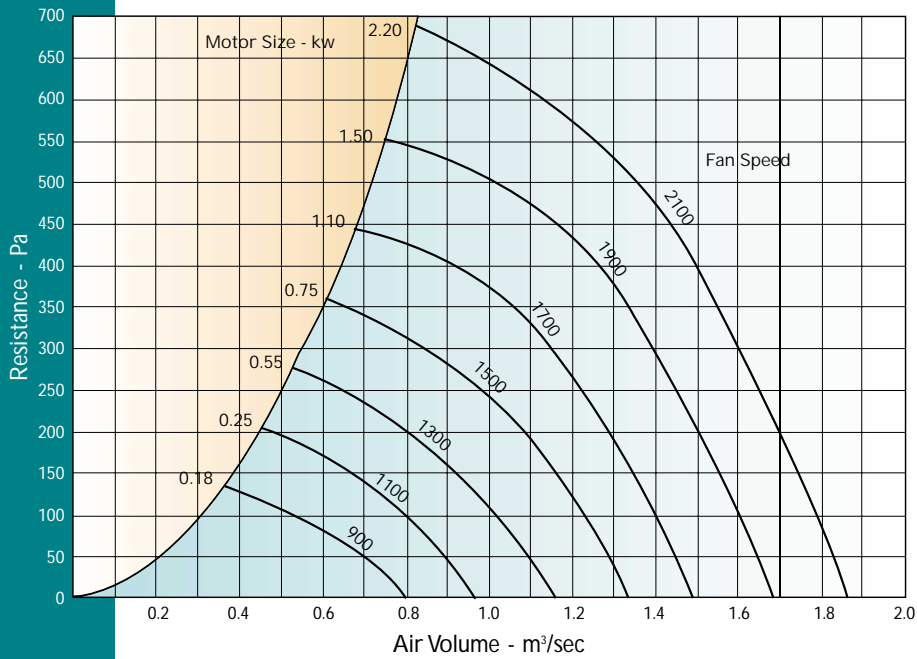

Model 140-STD	Sound Power Level Spectrum dB re10 ⁻¹² w. PWL								SPL dBA @3.0m
	Centre Frequency - Hz								
Fan Speed	63	125	250	500	1K	2K	4K	8K	
900	72	70	73	62	53	53	53	42	49
1100	77	76	76	68	55	55	55	48	53
1300	80	80	80	75	65	63	59	54	59
1500	78	80	82	77	69	67	63	58	61
1700	79	81	83	79	72	70	66	62	63
1900	83	82	83	84	76	72	69	65	67
2100	88	84	84	90	80	76	72	69	72

CFD 160 - STD

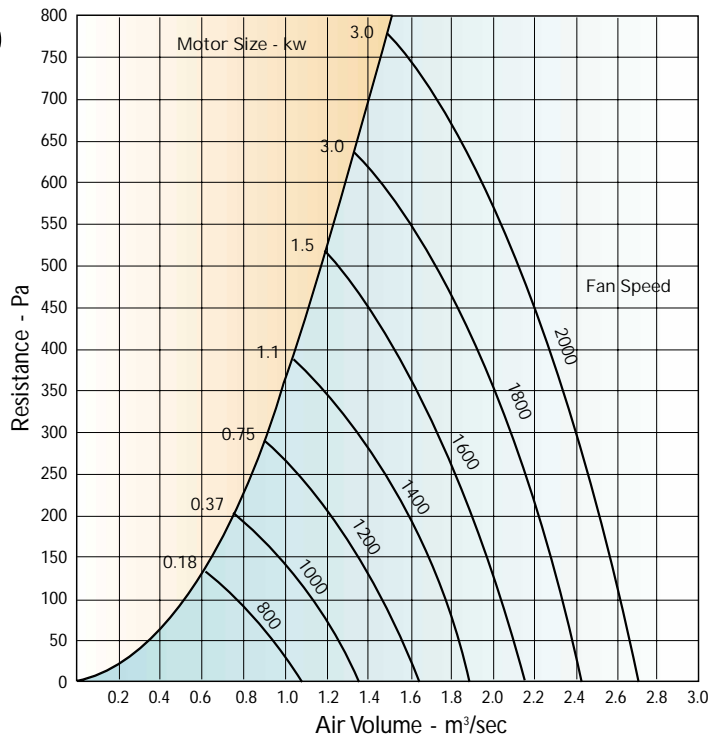

Model 160-STD	Sound Power Level Spectrum dB re10 ⁻¹² w. PWL								SPL dBA @3.0m
	Centre Frequency - Hz								
Fan Speed	63	125	250	500	1K	2K	4K	8K	
800	73	76	69	65	58	55	48	42	50
1000	75	76	74	71	62	60	55	51	55
1200	78	79	79	75	67	66	61	57	59
1400	80	82	84	79	71	70	66	61	63
1600	82	84	86	84	74	73	70	65	67
1800	85	86	89	89	77	76	73	69	71
2000	87	86	94	97	81	80	79	72	78

CFD 180 - STD

Unit Dimensions
Page 21

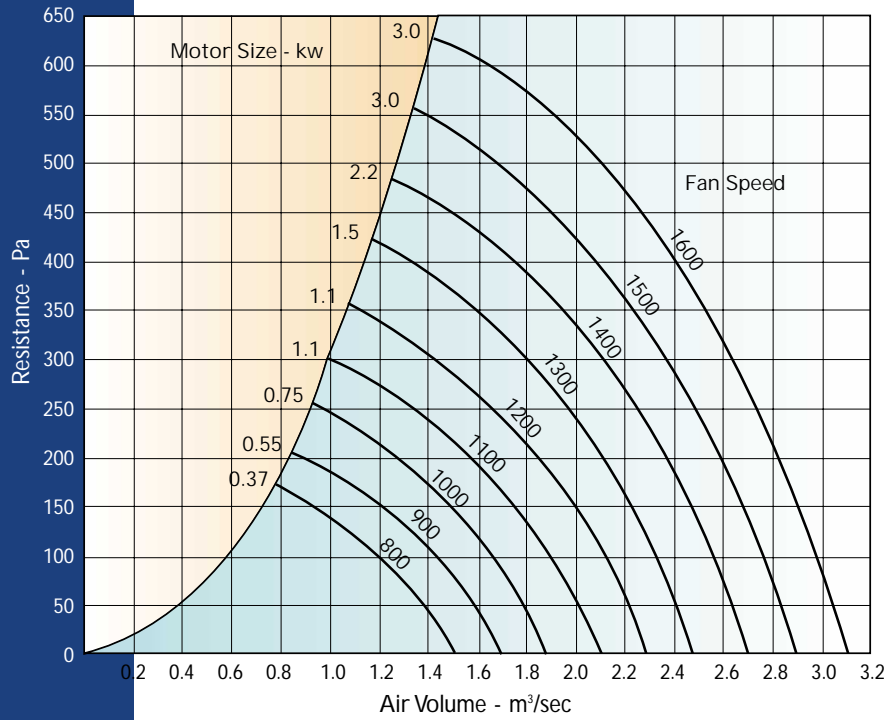

Model 180-STD	Sound Power Level Spectrum dB re10 ⁻¹² w. PWL								SPL dBA @3.0m
	Centre Frequency - Hz								
Fan Speed	63	125	250	500	1K	2K	4K	8K	
800	76	78	77	70	62	57	52	48	55
900	76	78	78	72	63	60	55	51	57
1000	76	78	80	76	65	62	57	54	59
1100	78	79	82	77	67	65	60	57	61
1200	80	80	83	78	70	67	62	60	62
1300	83	81	84	79	72	70	65	63	63
1400	82	82	86	81	73	72	67	65	65
1500	83	83	88	83	76	74	69	67	67
1600	83	83	90	85	78	77	71	69	70

CFD 180 - HP

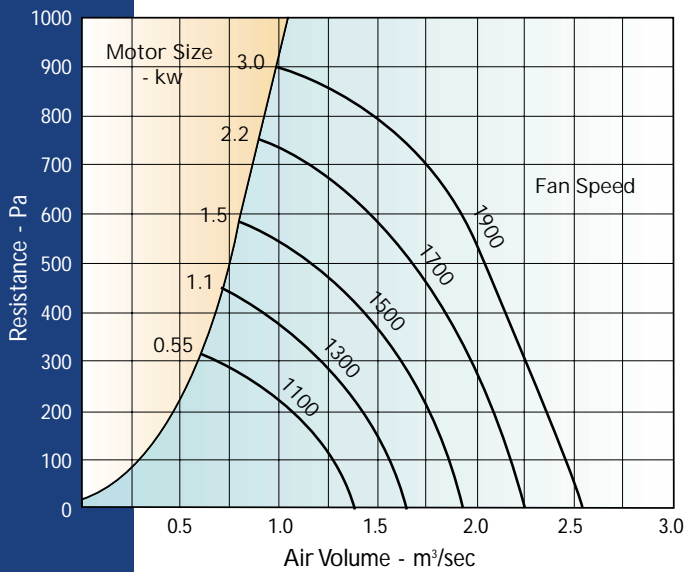

Model 180-HP	Sound Power Level Spectrum dB re10 ⁻¹² w. PWL								SPL dBA @3.0m.
	Centre Frequency - Hz								
Fan Speed	63	125	250	500	1K	2K	4K	8K	
1100	80	78	75	70	65	60	55	52	55
1300	82	80	78	74	69	65	61	57	59
1500	84	81	81	78	73	69	66	62	63
1700	84	83	84	85	77	73	70	66	67
1900	84	84	87	92	79	76	73	69	73

MAKE SELECTION

CFD 200 - STD

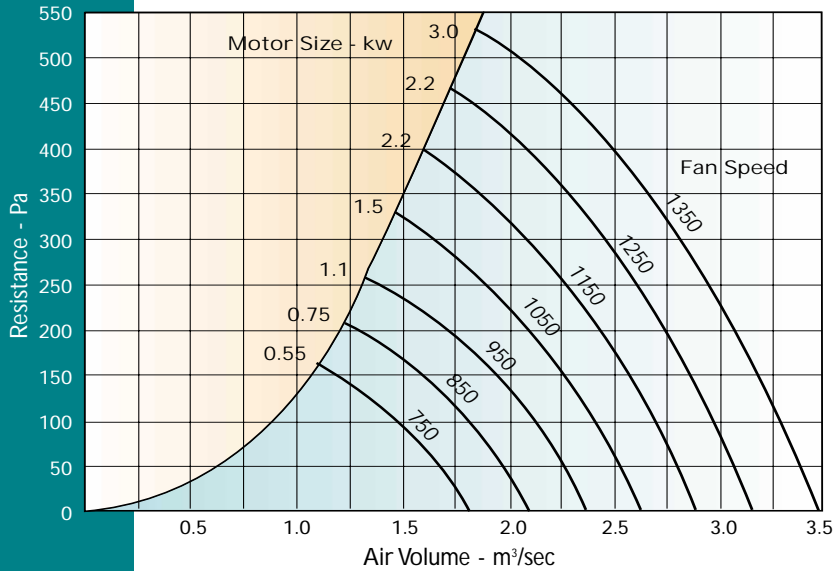

Unit Dimensions Page 21

Model 200-STD	Sound Power Level Spectrum dB re10 ⁻¹² w. PWL								SPL dBA @3.0m
	Centre Frequency - Hz								
Fan Speed	63	125	250	500	1K	2K	4K	8K	
750	80	81	75	73	64	60	56	49	57
850	81	82	78	75	67	63	59	52	59
950	84	82	81	77	69	66	61	56	61
1050	86	82	85	79	71	69	64	59	63
1150	88	83	87	80	73	70	66	62	66
1250	89	85	88	81	74	73	68	63	67
1350	90	88	90	83	77	75	71	66	69

CFD 200 - HP

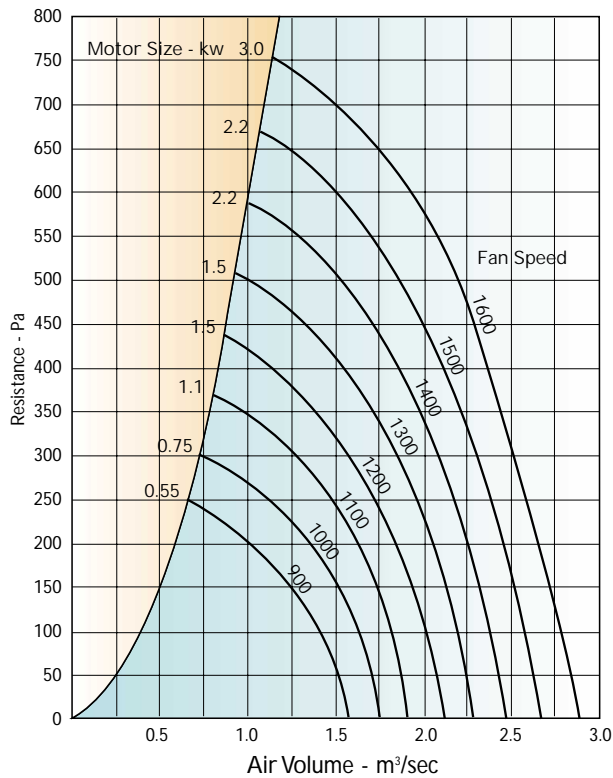

MAKE SELECTION

Model 200-HP	Sound Power Level Spectrum dB re10 ⁻¹² w. PWL								SPL dBA @3.0m
	Centre Frequency - Hz								
Fan Speed	63	125	250	500	1K	2K	4K	8K	
900	77	79	82	73	67	61	58	52	59
1000	76	79	85	77	69	65	62	56	62
1100	77	81	86	77	70	66	64	58	63
1200	81	82	86	79	72	70	66	61	64
1300	82	83	87	80	73	71	68	63	65
1400	86	85	89	84	77	75	73	67	68
1500	88	85	89	86	78	76	74	69	70
1600	87	85	88	88	79	77	73	69	71

CFD 240 - STD

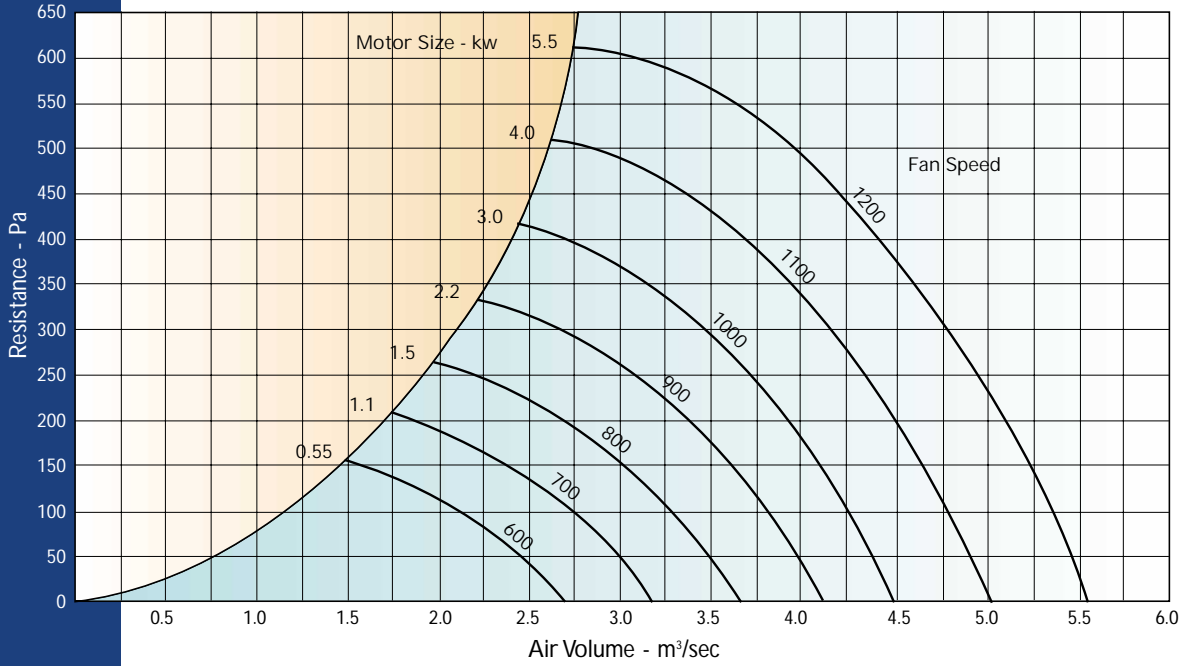

Model 240 - STD	Sound Power Level Spectrum dB re10 ⁻¹² w. PWL								SPL dBA @3.0m
	Centre Frequency - Hz								
Fan Speed	63	125	250	500	1K	2K	4K	8K	
600	78	81	77	72	68	63	55	49	57
700	79	83	80	73	71	66	59	52	60
800	82	85	83	75	74	71	63	57	63
900	83	86	87	79	77	74	67	61	66
1000	84	86	89	81	79	75	69	63	68
1100	86	84	91	81	79	76	70	65	69
1200	87	87	95	85	81	81	75	69	73

CFD 240 - HP

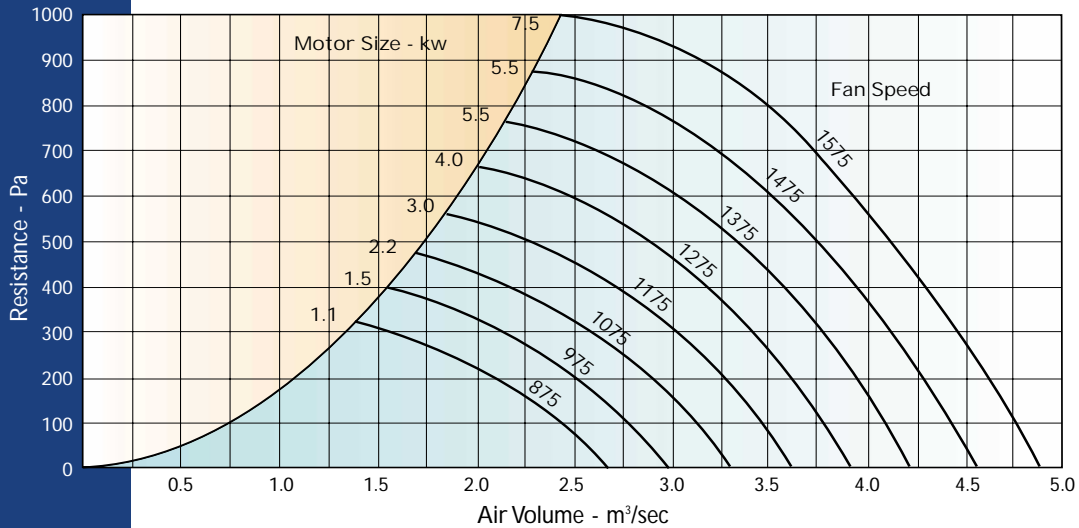

Model 240 - HP	Sound Power Level Spectrum dB re10 ⁻¹² w. PWL								SPL dBA @3.0m
	Centre Frequency - Hz								
Fan Speed	63	125	250	500	1K	2K	4K	8K	
875	83	83	81	77	71	67	64	58	61
975	84	84	83	78	74	70	67	62	64
1075	85	85	84	80	75	72	69	64	65
1175	85	85	86	81	77	75	72	67	67
1275	85	85	88	82	78	76	73	68	67
1375	85	85	90	83	79	77	73	69	69
1475	85	85	92	83	81	78	74	71	71
1575	85	85	94	84	82	78	75	72	72

MAKE SELECTION

CFD 300 - STD

Unit
Dimensions
Page 21

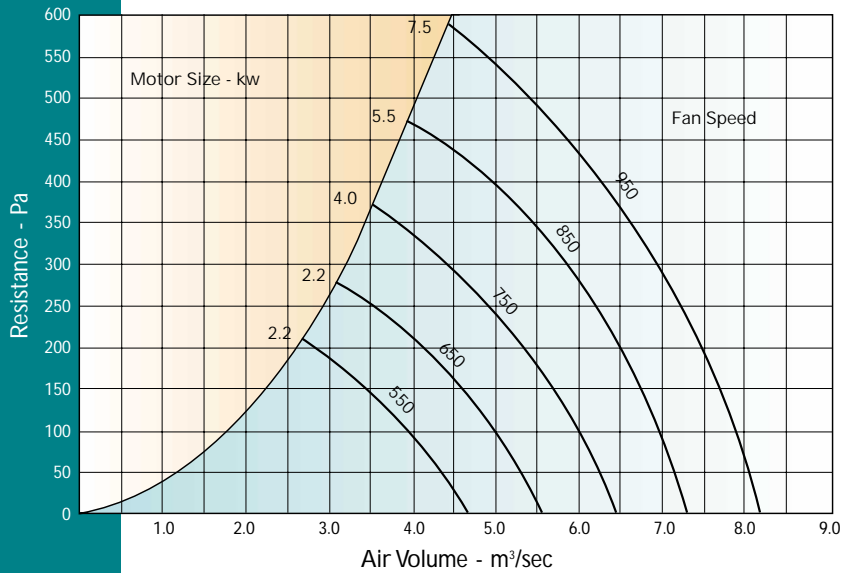

Model 300 - STD	Sound Power Level Spectrum dB re10 ⁻¹² w. PWL								SPL dBA @3.0m
	Centre Frequency - Hz								
Fan Speed	63	125	250	500	1K	2K	4K	8K	
550	82	83	79	72	69	65	59	54	59
650	84	88	82	75	73	69	64	60	63
750	86	92	85	78	76	73	68	65	66
850	89	94	91	81	79	76	71	68	69
950	91	95	95	83	81	78	74	70	72

CFD 300 - HP

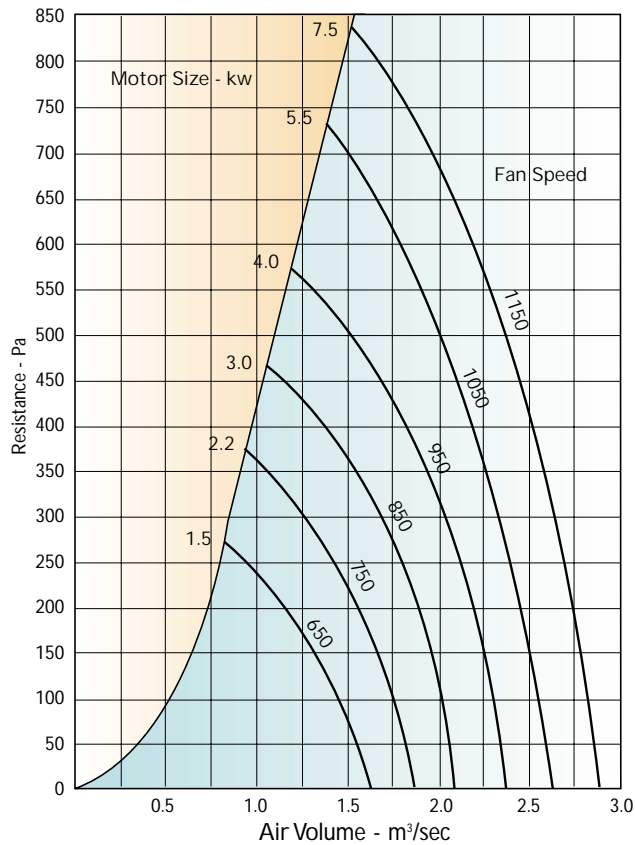

MAKE SELECTION

Model 300 - HP	Sound Power Level Spectrum dB re10 ⁻¹² w. PWL								SPL dBA @3.0m
	Centre Frequency - Hz								
Fan Speed	63	125	250	500	1K	2K	4K	8K	
650	85	82	80	74	67	67	63	54	60
750	86	84	83	76	71	70	67	59	63
850	87	87	88	78	74	72	70	64	66
950	87	88	91	79	76	75	73	68	68
1050	88	87	91	81	79	77	75	71	69
1150	89	86	90	83	81	78	77	73	71

CFD 360 - STD

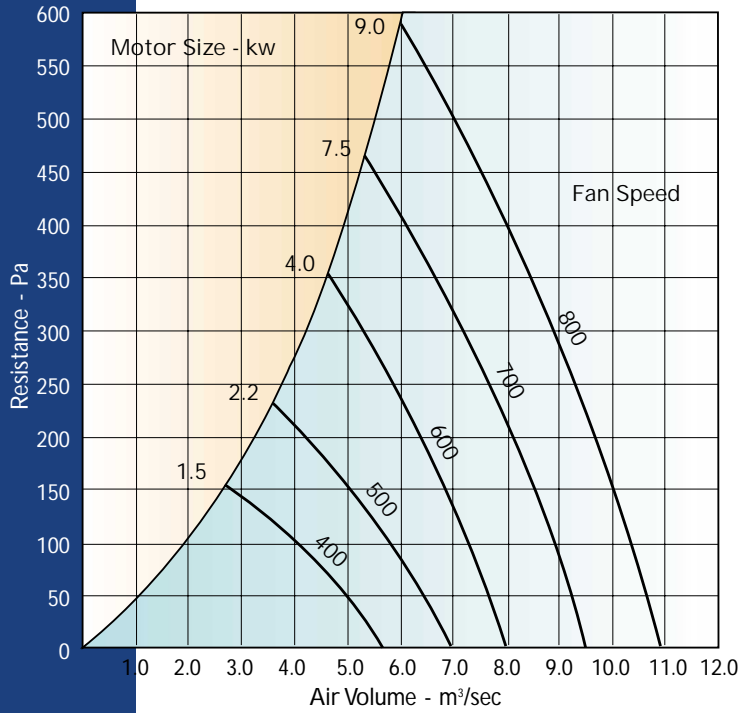

Model 360 - STD	Sound Power Level Spectrum dB re10 ⁻¹² w. PWL								SPL dBA @3.0m
	Centre Frequency - Hz								
Fan Speed	63	125	250	500	1K	2K	4K	8K	
400	85	82	76	68	68	64	58	53	57
500	89	84	81	73	73	68	60	55	60
600	90	91	85	77	76	74	68	63	66
700	92	95	88	81	80	77	73	68	69
800	95	98	89	84	84	81	76	71	73

CFD 360 - HP

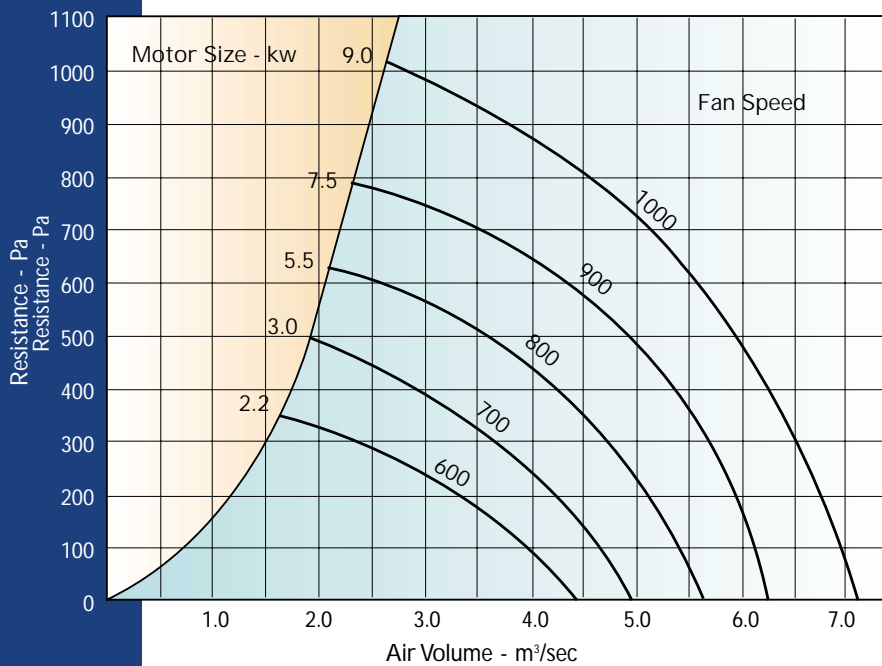

Model 360 - HP	Sound Power Level Spectrum dB re10 ⁻¹² w. PWL								SPL dBA @3.0m
	Centre Frequency - Hz								
Fan Speed	63	125	250	500	1K	2K	4K	8K	
600	88	89	82	73	67	64	62	59	60
700	86	88	82	75	71	68	66	63	62
800	84	87	82	77	75	72	70	67	64
900	87	87	86	81	79	76	73	71	68
1000	91	87	91	84	81	78	75	73	71

MAKE SELECTION

CFD Dimensions

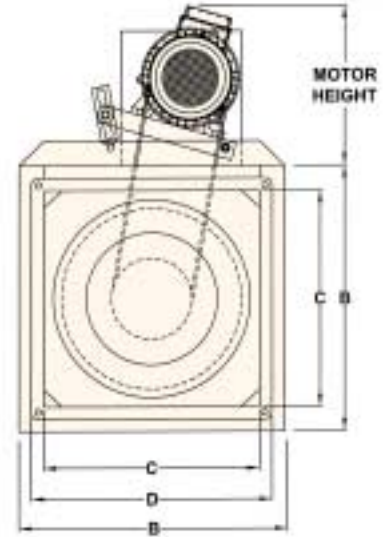
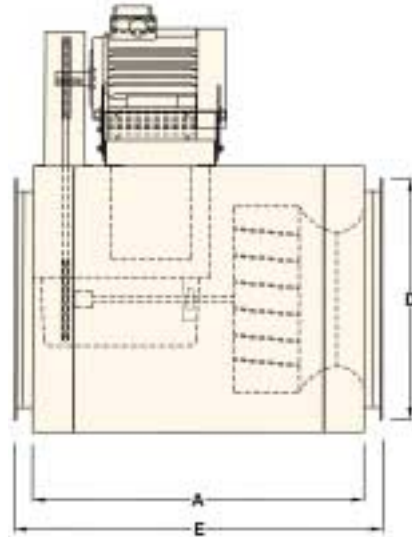
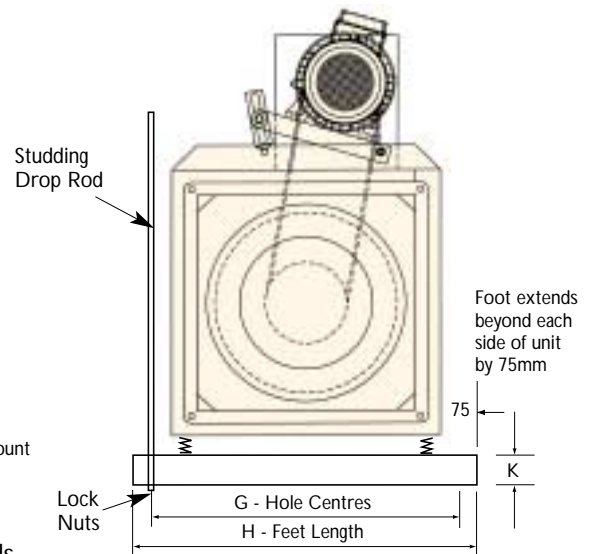
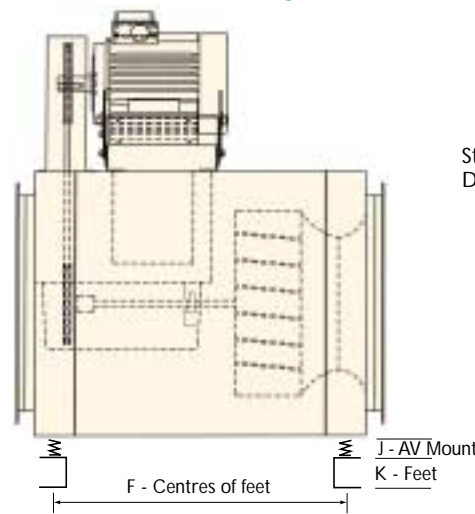
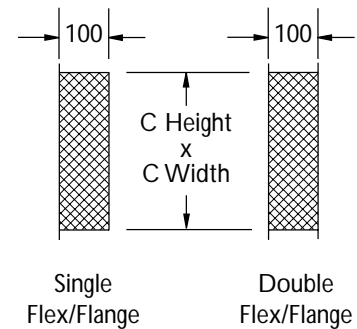

Illustration showing feet details:



Mounting feet can be used with drop rods or fastened down to base.

Motor Size kW	Max. Motor Height mm
0.18	310
0.25	320
0.55, 0.75 & 1.1	330
1.5 & 2.2	350
3.0 & 4.0	380
5.5	450
7.5	480
9.0	505



Model No.	Dimensions - mm										Weight* Kgs
	A	B	C	D	E	F	G	H	J	K	
CFD 80	533	381	283	323	593	503	451	531	25	40	34
CFD 100	533	432	334	374	593	503	502	582	25	40	38
CFD 140	556	582	505	545	616	526	652	732	25	40	63
CFD 160	660	660	581	621	720	630	730	810	25	40	73
CFD 180	711	711	607	647	795	681	781	861	25	40	86
CFD 180 HP	711	711	607	647	795	681	781	861	25	40	86
CFD 200	813	813	708	748	893	783	883	963	25	40	100
CFD 200 HP	813	813	708	748	893	783	883	963	25	40	100
CFD 240	875	991	886	946	955	834	1061	1141	25	40	145
CFD 240 HP	875	991	886	946	955	834	1061	1141	25	40	145
CFD 300	965	1168	1064	1124	1045	935	1238	1318	50	100	191
CFD 300 HP	965	1168	1064	1124	1045	935	1238	1318	50	100	191
CFD 360	1067	1320	1220	1257	1147	1037	1390	1470	50	100	273
CFD 360 HP	1067	1320	1220	1257	1147	1037	1390	1470	50	100	273

* Weight varies with motor size.

CFD in Weatherproof Housing

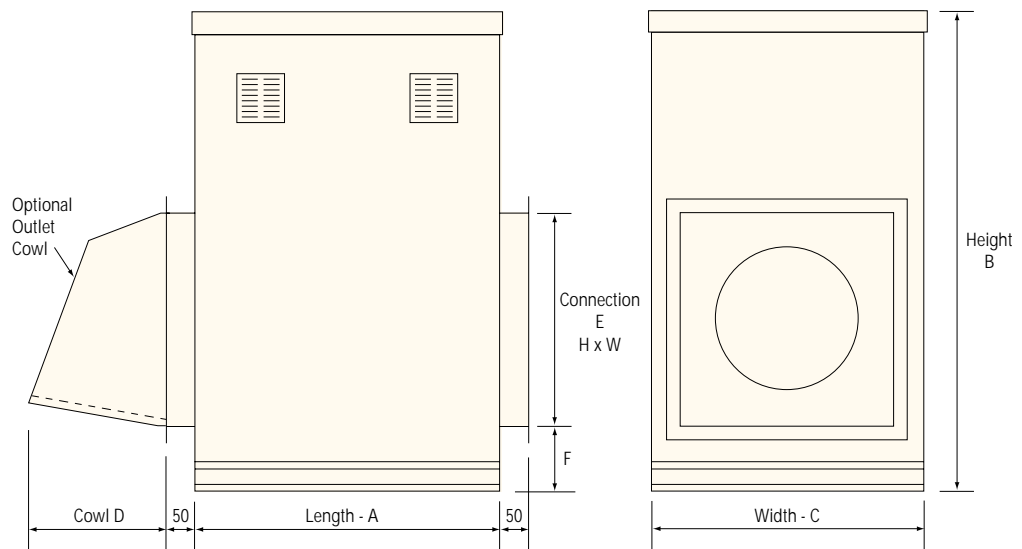

Model	Length A	Height B	Width C	Cowl D	Connection E	Spigot to Base F	*Case Weight Kgs
CFD 80	820	800	540	300	283	240	48
CFD 100	820	900	590	300	334	240	55
CFD 140	800	1100	750	350	505	230	71
CFD 160	900	1200	820	400	581	230	83
CFD 180+HP	980	1250	880	450	607	243	97
CFD 200+HP	1100	1350	1000	500	708	243	116
CFD 240+HP	1300	1680	1200	600	886	267	253
CFD 300+HP	1400	1950	1400	600	1064	352	290
CFD 360+HP	1500	2050	1550	600	1220	352	329

All dimensions in mm.

*Add case weight to unit weight page 21.

All weatherproof units are completely corrosion proof, the cases being manufactured from galvanised sheet steel, then polyester powder coated and baked at high temperature, providing an attractive and durable finish. The standard colour is light grey to BS 00A05. The case has an acoustic foam lining ensuring minimal noise breakout. The Centrifume unit is fully vibration isolated within the weatherproof case, including flexible connections and AV mounts. Access panels are provided to both sides, plus removable top, for internal cleaning and maintenance.

Fitted Silencers

Available to both inlet and outlet with channel base and outlet cowl as required.

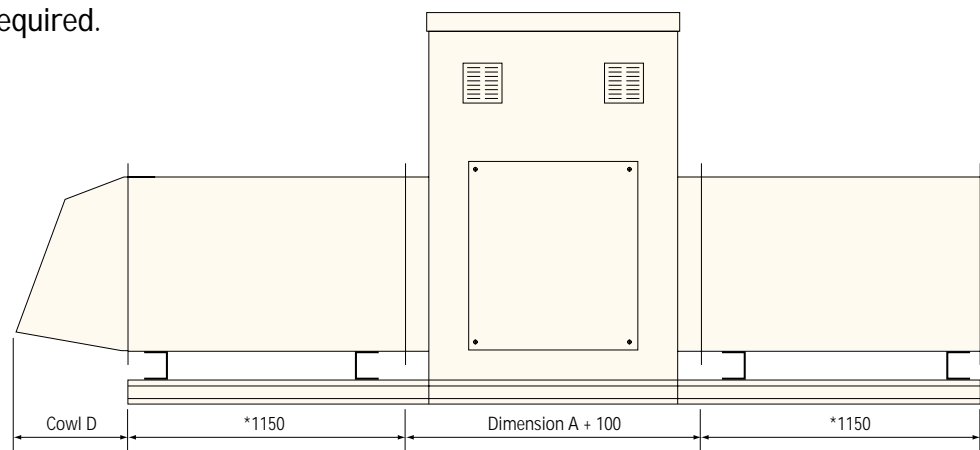

*Standard length of cleanable silencers.

CFS Silencers



Silencer with side access panel removed

The CFS silencer range has the **unique feature** of a removable panel from which the acoustic splitters can be withdrawn for cleaning.

Due to the compact size of the CFD unit relative to the air volume, in some instances the silencer will not match the CFD case, and duct transitions will be necessary. For those silencers that do match the CFD unit, a 300mm long duct section is recommended between the silencer and unit.

The CFS silencers can also be manufactured in non-cleanable construction for uncontaminated air, please specify model CFS/NC for this type.

The silencer case is galvanised sheet steel of lock formed construction, terminating in proprietary duct flanges.

Silencer Attenuation

Silencer Model	Insertion Loss - dB							
	Centre Frequency - Hz							
	63	125	250	500	1K	2K	4K	8K
CFS 5	5	9	16	30	39	39	31	26
CFS 10	5	10	19	35	45	45	36	27
CFS 20	3	6	13	23	29	29	17	10
CFS 30	4	8	16	29	37	37	27	17
CFS 45	3	6	13	23	29	29	17	10
CFS 55	4	8	16	29	37	37	27	17
CFS 65	3	6	13	23	29	29	17	10

Silencer Dimensions

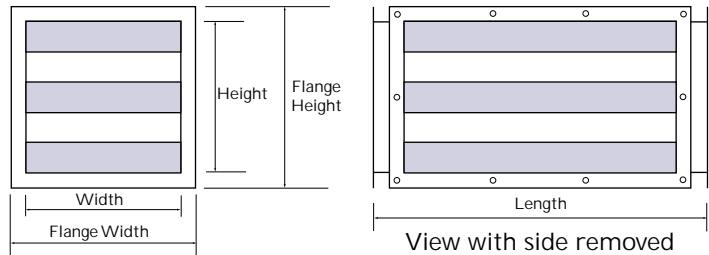

Silencer Model	Dimensions - mm					Weight kgs
	Width	Flange Width	Height	Flange Height	Length	
CFS 5	334	374	334	374	1150	25
CFS 10	505	545	505	545	1150	50
CFS 20	607	647	607	647	1150	60
CFS 30	825	885	825	885	1150	90
CFS 45	886	946	886	946	1150	98
CFS 55	1064	1124	1064	1124	1150	140
CFS 65	1220	1320	1220	1320	1150	171

Silencer Air Pressure Loss

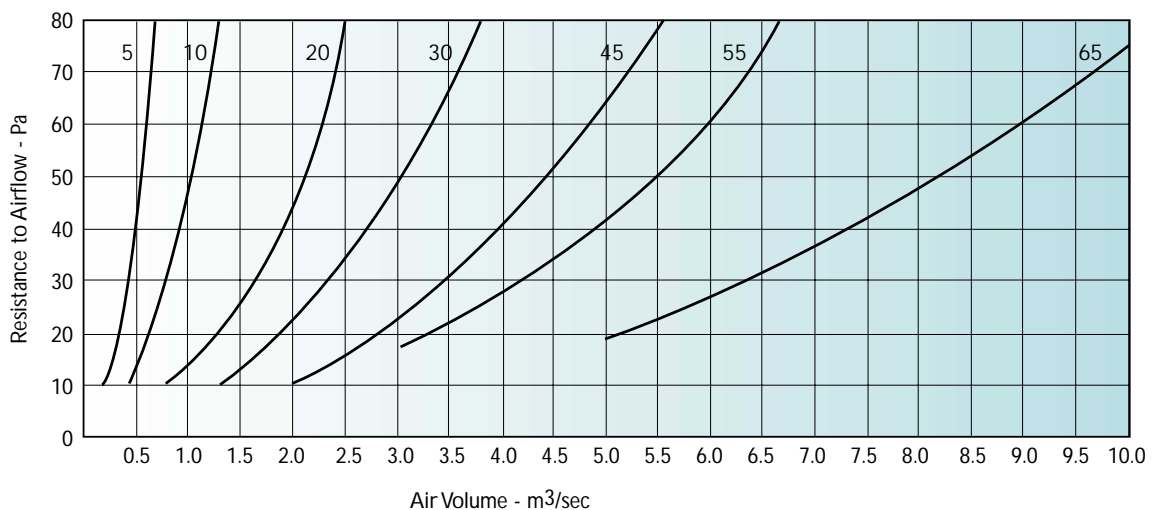

Electrical Details

CFR roof units are normally fitted with a weatherproof isolator. This includes 1 phase and 3 phase single speed motors and all 3 phase two speed motors.

Two Speed Controllers consist of an enclosure with high / low / off switch, delay timer, overloads, contactors, run and trip lights for each speed, door isolator, labelling.

Motor kW	FLC's amps	Model
1.1 / 0.19	2.8 / 1.34	CFEL 3615
1.8 / 0.37	4.0 / 1.5	CFEL 6015
2.2 / 0.45	5.0 / 1.9	CFEL 6027
3.0 / 0.6	6.8 / 2.9	CFEL 8536
3.7 / 0.75	7.9 / 3.0	CFEL 8536
5.5 / 1.1	11.4 / 4.1	CFEL 1250
7.5 / 1.9	15.5 / 6.3	CFEL 1885
9.2 / 1.85	18.0 / 6.0	CFEL 1885

The enclosure size for all panels up to 5.5/1.1kw motor is 300mm wide x 400mm high x 150mm deep, and for 7.5/1.9kw and 9.2/1.85kw motors is 400mm wide x 500mm high x 150mm deep.

Three Phase Motor Speed Control using a matched three phase inverter.

Model Size	FLC amps	Inverter Model
0.37kW	1.18	IN3434 - 0037
0.55kW	1.50	IN3434 - 0055
0.75kW	2.00	IN3434 - 0075
1.1kW	2.60	IN3434 - 0110
1.5kW	3.90	IN3434 - 0150
2.2kW	5.80	IN3434 - 0220
3.0kW	7.10	IN3434 - 0300
4.0kW	8.50	IN3434 - 0400
5.5kW	12.00	IN3434 - 0550
7.5kW	16.50	IN3434 - 0750
9.0kW	18.30	IN3434 - 0900

Up to and including 2.2kw the standard inverter has an IP20 housing and accessible electrical connections. These are only suitable for mounting in a control panel or in the optional IP54 enclosure supplied by VES. Sizes 3.0kW to 9.0kW come with an IP54 enclosure as standard.

With each inverter a local fan speed controller with on/off switch is supplied, model CFSC1, and the inverter is programmed at VES to match the controller before despatched.

Single Phase Motor Speed Control is achieved by using a 240 volt single phase supply into the single phase inverter, which converts the supply to three phase to the motor. Therefore, select a standard three phase motor for the Centrifume, but provide a single phase supply up to the inverter, and three phase wiring from the inverter to the motor.

Model Size (3 phase)	Rated Current 1 Phase	Inverter Model
0.18kW	1.4 amps	IN1234 - 0018
0.25kW	1.7 amps	IN1234 - 0025
0.37kW	2.2 amps	IN1234 - 0037
0.55kW	3.0 amps	IN1234 - 0055
0.75kW	4.3 amps	IN1234 - 0075
1.1kW	5.9 amps	IN1234 - 0110
1.5kW	7.0 amps	IN1234 - 0150
2.2kW	9.0 amps	IN1234 - 0220

The single phase inverters have an IP20 housing and accessible electrical connections. These are only suitable for mounting in a control panel or in the optional IP54 enclosure supplied by VES. With each inverter a local fan speed controller with on/off switch is

supplied, model CFSC1, and the inverter is programmed at VES to match the controller before despatch.



We care about air

VES Andover Limited
Eagle Close, Chandlers Ford Industrial Estate,
Chandlers Ford, Eastleigh, Hampshire SO53 4NF

Tel: 08702-40-43-40
Fax: 08702-40-45-50
e-mail: vesltd@ves.co.uk
www.ves.co.uk



ISO 9001-2000
Cert. No. Q5375

VES reserve the right to amend product specifications and details without notice.

Leaflet No. 787-5/02